

# Moderno Classico

**Per una più ampia  
visione di tutti  
i nostri prodotti,  
ricordati di consultare  
anche il catalogo Inox.**

**Remember to check  
out our inox range  
catalogue, for a broader  
view of our products.**

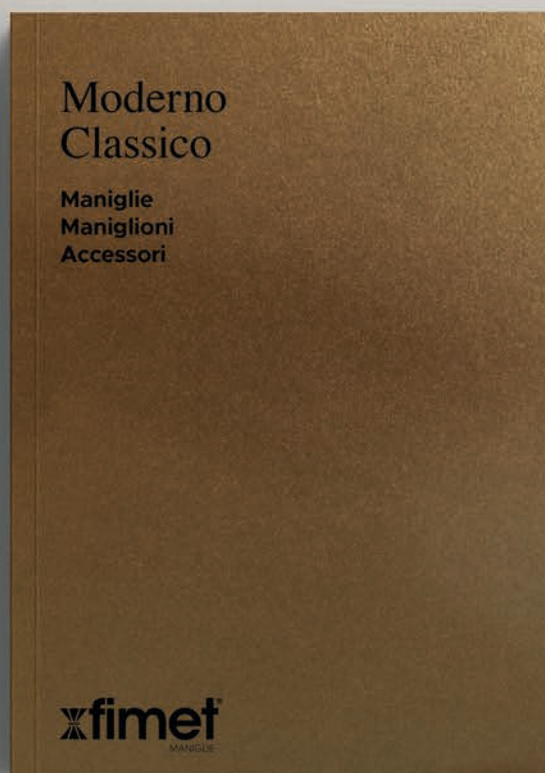
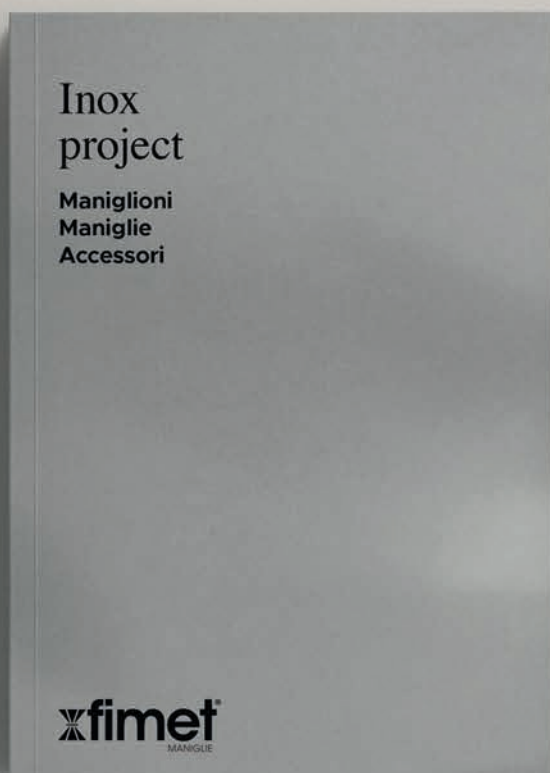

# Index

## **8 Profilo aziendale**

Company profile

## **38 Moderno**

Modern

## **154 Classico**

Classic

## **228 Easy line**

Easy line

## **234 Accessori**

Accessories

## **253 Kit per porte scorrevoli**

Sliding doors flush handles

## **266 Rosette Bocchette Placche Componenti Sistemi di assemblaggio**

Roses / Escutcheons / Plates

Components

Assembly systems

## **286 Certificazioni**

Certificates

## **287 Condizioni di vendita**

Terms of sale



**ADELE**

1239.208  
PAG. 92



**ADELE**

1239.213  
PAG. 94



**ALICIA**

1220.208  
PAG. 58



**ALICIA**

1220.213  
PAG. 60



**CLOÈ**

1171  
PAG. 78



**CLUB**

110  
PAG. 136



**CORSA**

1354.208  
PAG. 82



**CORSA**

1354.213  
PAG. 84



**CUT**

164  
PAG. 110



**DANIELA**

179  
PAG. 120



**DIAMOND**

199  
PAG. 122



**EASY**

1301  
PAG. 98



**EASY**

1301.241  
PAG. 152



**ELLE**

132C  
PAG. 102



**EVA**

1445  
PAG. 76



**FLAKE**

1355  
PAG. 90



**FLY**

130  
PAG. 134



**FUTURA**

1332  
PAG. 44



**GIORGIA**

169  
PAG. 124



**GRACE**

127  
PAG. 132



**HORNET**

145  
PAG. 126



**ICE**

168  
PAG. 100



**ICO**

1225.208  
PAG. 62



**ICO**

1225.213  
PAG. 64



**INFINITY**

1501  
PAG. 46



**ITALIA**

1353  
PAG. 88



**JOLIE**

126  
PAG. 130



**KATE**

122  
PAG. 128



**KUBO**

1317  
PAG. 112



**KUBO**

1317.243  
PAG. 146



**MUSA**

180R  
PAG. 96



**NEW YORK**

1215  
PAG. 42



**OLANDA**

102.241  
PAG. 150



**ONDA**

1230.208  
PAG. 52



**ONDA**

1230.213  
PAG. 54



**ONDA**

1230.241  
PAG. 142



**ORIGAMI**

1210  
PAG. 72



**PLANA**

1200  
PAG. 74



**PRISMA**

1351  
PAG. 86



**PUNTO**

1205.208  
PAG. 68



**PUNTO**

1205.213  
PAG. 70



**PUNTO**

1205.244  
PAG. 140



**PURA**

1352  
PAG. 80



**PURA**

1352.243  
PAG. 144



**SABRINA**

159  
PAG. 118



**SHAPE**

1320  
PAG. 114



**SHAPE**

1320.241  
PAG. 148



**SLIM**

1063  
PAG. 104



**ULTIMA**

1502  
PAG. 48



**VIPER**

1401  
PAG. 106



**WAVE**

190  
PAG. 108

# Classico / Classic



**ALT WIEN**

196  
PAG. 204



**ANASTASIA**

198  
PAG. 210



**ANNA**

177  
PAG. 178



**ANNA ESSENCE**

177.2  
PAG. 180



**BLOSSOM**

1378  
PAG. 168



**CALLIOPE**

151  
PAG. 192



**DOLL**

141  
PAG. 218



**DUCK**

153  
PAG. 200



**DUFFY**

1379  
PAG. 172



**EAGLE**

150  
PAG. 198



**FLORA**

147  
PAG. 182



**FLORA**

147P  
PAG. 214



**FRAU**

137 O.208  
PAG. 162



**FRAU**

137 O.213  
PAG. 164



**JULIETTE**

152  
PAG. 188



**LADY**

148  
PAG. 212



**MARINA**

108  
PAG. 220



**MARION**

1444  
PAG. 158



**MICHELLE**

106  
PAG. 176



**MICHELLE**

106P  
PAG. 216



**NICOLE**

1377  
PAG. 166



**PARIS**

154  
PAG. 190



**PISA**

119  
PAG. 194



**REGINA**

105  
PAG. 184



**RETRÒ**

1380  
PAG. 170



**RODI**

138  
PAG. 196



**SQUARE PORCELLANA**

160P  
PAG. 224



**SQUARE PELLE**

160.3  
PAG. 226



**STEFANIA**

195  
PAG. 202



**STONE**

161S  
PAG. 222



**TASHA**

1028  
PAG. 174



**TASHA**

1028P  
PAG. 208



**VENEZIA**

1027  
PAG. 160



**WIEN**

109  
PAG. 186

# Fimet una storia di passione, ricerca e qualità italiana.

A story of  
passion,  
research and  
Italian quality.

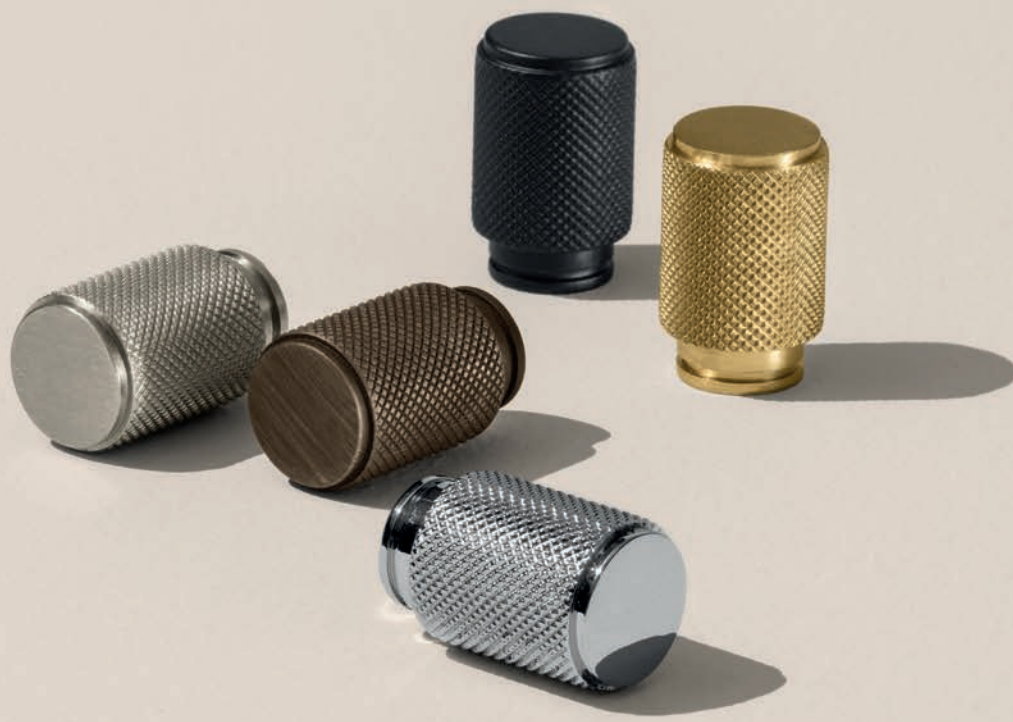

<sup>IT</sup> La nostra realtà nasce nel 1986, quando Vittore Bianchi fonda la Fimet, sulla base di una già consolidata esperienza imprenditoriale, dedicandosi a un elemento protagonista dell'arredo e dell'interior design: la maniglia. Da allora siamo cresciuti, restando sempre fedeli al nostro territorio: la Valle Sabbia, in provincia di Brescia, storico distretto produttivo nel settore delle lavorazioni metalliche. Con il trascorrere del tempo, Vittore è stato affiancato dai figli Luca e Marica nella gestione di un'azienda che si è evoluta non solo nelle dimensioni e nelle tecnologie, ma anche nella flessibilità produttiva e nella cultura del progetto. Oggi ci proponiamo come un partner capace di interpretare le più diverse esigenze funzionali e stilistiche dei nostri interlocutori, unendo una visione internazionale con un'eccellenza qualitativa tipicamente italiana.

# About us

<sup>EN</sup> Our company was first established in 1986, when Vittore Bianchi founded Fimet, drawing on his long-established entrepreneurial experience to focus on an essential component of furniture and interior design: handles. We have grown since, and stayed loyal to our land all along: Valle Sabbia, in the province of Brescia, a historic production district in the metalworking industry. Over time, Vittore has been supported by his children Luca and Marica in managing a company that has evolved not only in size and technology, but also in terms of production flexibility and design culture. Fimet partners with its customers to meet their most diverse functional and stylistic requirements, combining an international vision with typically Italian top-quality standards.

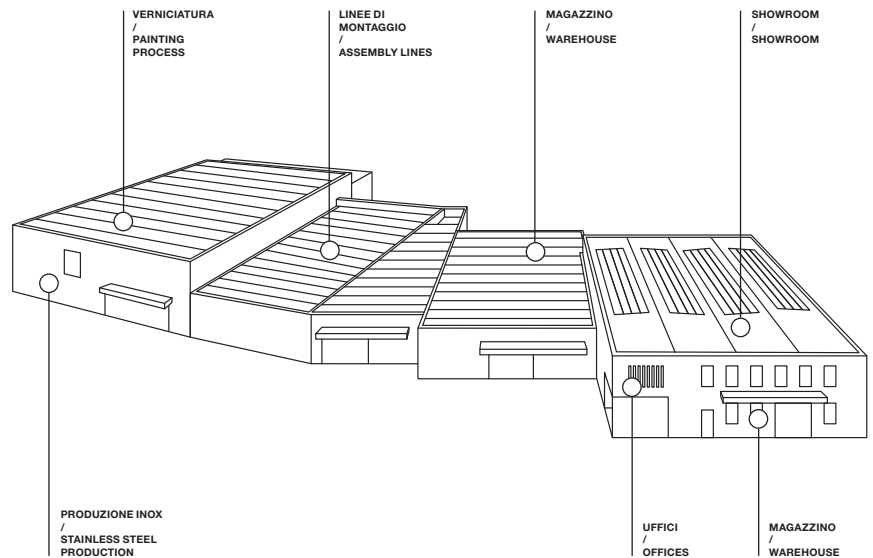

1986

**Fimet viene fondata a Vestone, in Valle Sabbia.**

Fimet was founded in Vestone, in the Valle Sabbia area.

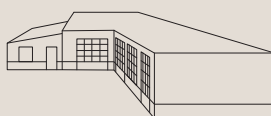

1998

**La maniglia Club è il primo modello esportato con successo sul mercato tedesco.**

The Club handle is the first model to be successfully exported to the German market.

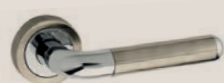

1999

**Viene inaugurata la seconda sede aziendale a Merlaro Vestone.**

Opening of a second facility in Merlaro Vestone.



2010

**La maniglia Michelle apre a Fimet le porte del mercato di alta gamma.**

The Michelle handle opens the door to the high-end market.



2015

**Fimet inizia a collaborare con designer italiani, per rivolgersi a nuove fasce di mercato.**

Fimet begins to collaborate with Italian designers to target new market segments.

# About our history

## 2017

**Fimet si trasferisce in una sede più ampia a Casto, sempre in Valle Sabbia.**

Fimet moves its headquarters to a larger location in Casto, still in the Valle Sabbia area.

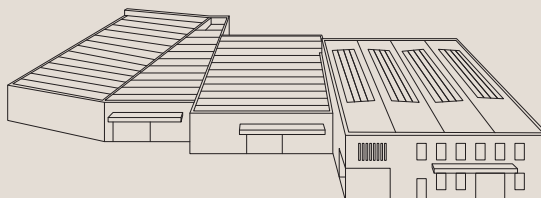

## 2018

**Viene introdotta una nuova gamma di prodotti in acciaio inox, standard e su misura.**

Launch of a range of standard and made-to-measure stainless-steel products.

## 2020

**La maniglia Punto, disegnata da Robby Cantarutti, vince il Red Hot Design Award.**

The Punto handle by Robby Cantarutti wins the Red Dot Design Award.



## 2021

**Fimet amplia il suo reparto verniciatura a polvere ecosostenibile.**

Fimet expands its eco-friendly powder coating department.

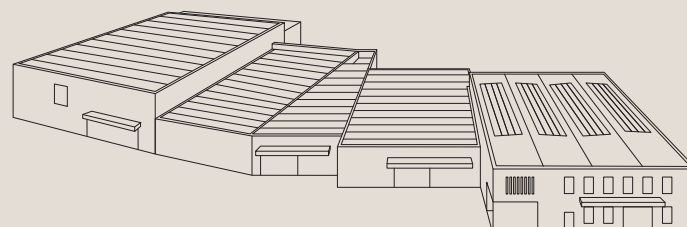

# La nostra filosofia

Our target



IT Ogni giorno ci mettiamo al lavoro con un obiettivo preciso: realizzare delle maniglie completamente in sintonia con le esigenze funzionali, qualitative e stilistiche dei nostri clienti. Per questo seguiamo direttamente tutte le fasi del processo: selezione dei materiali, progettazione e prototipazione, stampaggio, lavorazioni, finitura. Dalle maniglie classiche e contemporanee in ottone, lega di zinco e acciaio inox, ai maniglioni e accessori in acciaio inox e leghe in alluminio, abbiamo sviluppato una gamma di soluzioni completa, personalizzabile e in continua evoluzione. Esprimiamo i più alti livelli di professionalità e flessibilità anche nei nostri servizi commerciali: un fattore essenziale per il nostro successo sul mercato e soprattutto per la soddisfazione dei nostri clienti.

Fimet è da sempre specializzata nella produzione di maniglie.

Fimet specialises in the production of handles.



# About our values

<sup>EN</sup> Every day we start working with a specific goal in mind: to create handles that are fully in line with our customers' requirements for functionality, quality and style. That's why we directly oversee every single stage of the production process: material selection, design and prototyping, moulding, manufacturing and finishing. We have developed a comprehensive range of customisable and constantly evolving solutions, encompassing a variety of styles and materials, such as classic and contemporary handles made from brass, zinc alloy and stainless steel, as well as pull handles and accessories crafted from stainless steel and aluminium alloys. The highest standards of expertise and flexibility are also reflected in our sales services : a key factor for our success in the market, while guaranteeing full customer satisfaction.





La personalizzazione  
è uno dei punti di  
forza di Fimet.  
Customisation is one  
of Fimet's strengths.

# Prodotti ready made, custom, on demand.

**Ready-made,  
customised and  
on demand  
products.**

<sup>IT</sup> Gestiamo l'intero processo produttivo nel nostro stabilimento, unendo lavorazioni artigianali e tecnologie di precisione, come nella migliore tradizione del Made In Italy. Questo ci consente di avere un totale controllo sulla qualità e di offrire un elevato livello di personalizzazione dei prodotti presenti nelle nostre collezioni, sempre garantendo la massima puntualità nelle consegne. Il nostro ufficio tecnico è inoltre a disposizione per sviluppare delle soluzioni su progetto del cliente: dallo studio di fattibilità, alla realizzazione dello stampo, alla produzione in serie di maniglie completamente originali e uniche.

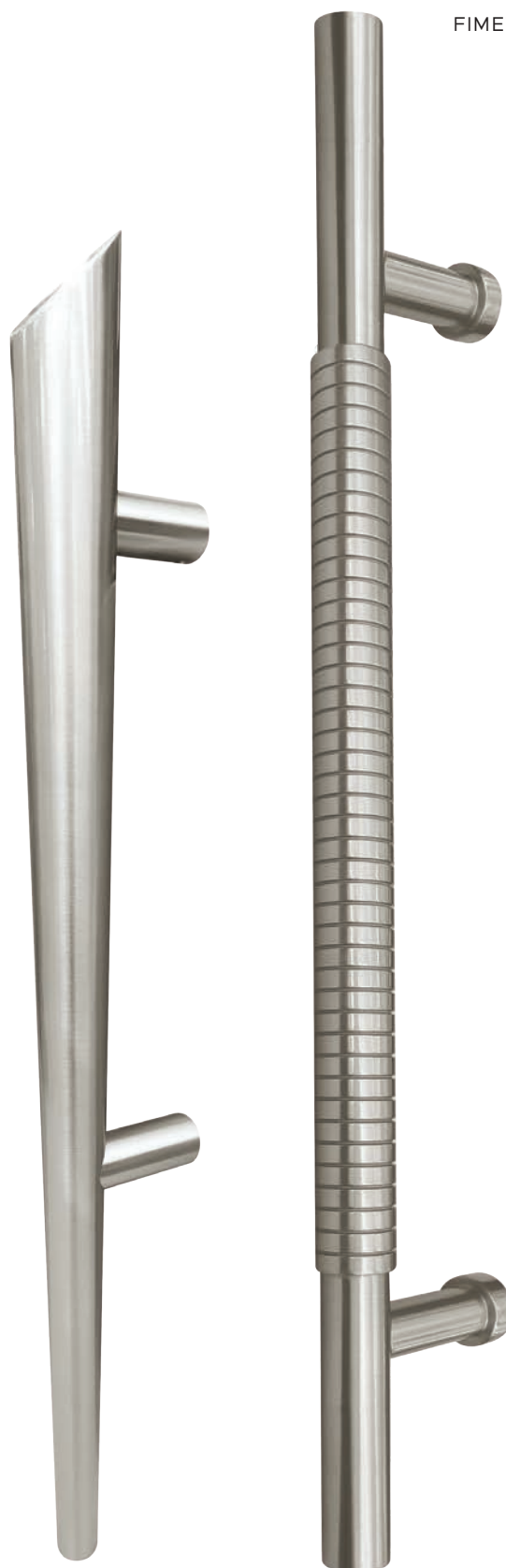

<sup>EN</sup> We manage the entire production process in our factory, combining craftsmanship and precision technologies in line with the best Italian manufacturing tradition. This allows us to have complete control over quality and offer a high level of product customisation in our collections, while always ensuring timely deliveries. Our technical department is also available to develop solutions based on our customers' designs: from feasibility studies to mould construction and mass production of utterly original and unique handles.

Maniglia  
per porta

Handle  
for door

Pomolo  
per porta

Knob  
for door



# Our solutions

<sup>IT</sup> Realizziamo un sistema completo di maniglie e accessori, per soddisfare ogni esigenza funzionale e stilistica, in sintonia con qualsiasi progetto d'interni: dagli ambienti domestici, agli uffici, agli spazi commerciali e collettivi.

<sup>EN</sup> Our comprehensive range of handles and accessories has been designed to meet all the functional and stylistic requirements of any interior design project, from residential to office interiors, commercial and public spaces.

Maniglia  
per finestra

Handle  
for window

Maniglione  
alzante per porta  
scorrevole

Lift and slide pull  
handle for sliding  
door

Maniglione  
per porta

Pull handle  
for door

Fermaporta  
a pavimento

Floor door  
stopper

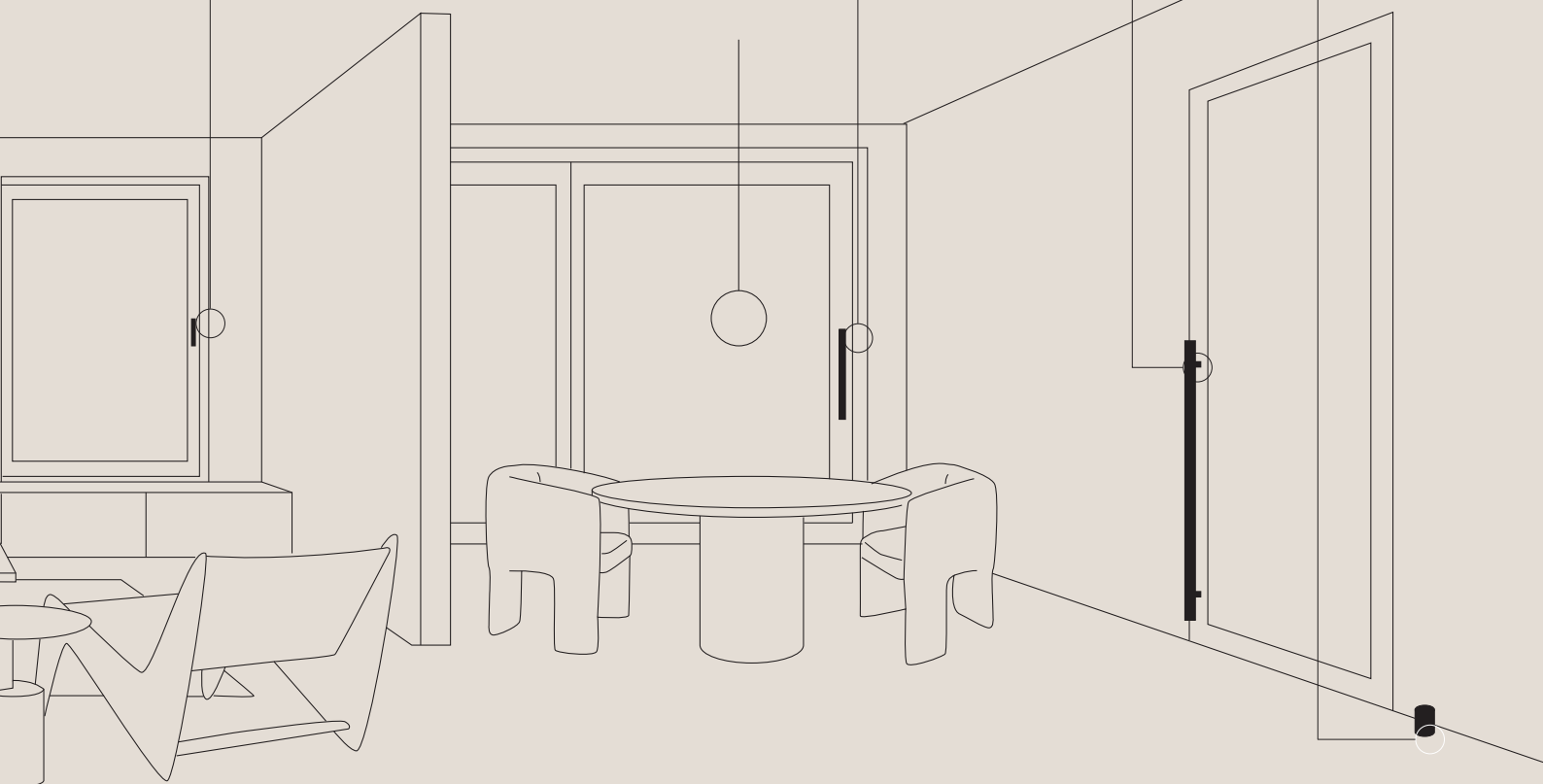



# About our nature

Il panorama che ci circonda, la Valle Sabbia, con le sue montagne incontaminate e le sue antiche tradizioni, ci ispira ad abbracciare un comportamento etico fondato sul rispetto per la natura e le persone. Ecco perché abbiamo scelto di non utilizzare materiali e processi nocivi, in sintonia con le linee guida europee sulla sostenibilità. In particolare, il nostro reparto di verniciatura ha un sistema di lavaggio ad acqua che consente di risparmiare energia e utilizza vernici a polveri atossiche che non contaminano il suolo e l'atmosfera: un contributo concreto alla qualità dell'ambiente e della vita di tutti.

The Valle Sabbia landscape surrounding us with its pristine mountains and ancient traditions, inspires us to embrace an ethical behaviour based on respect for nature and people. That is why we chose not to use harmful products and processes, in line with European sustainability guidelines. In particular, our painting department has a water washing system that saves energy and uses non-toxic powder paints that do not contaminate the soil and the atmosphere: a tangible contribution to the quality of the environment and of human life.

## Guardiamo all'ambiente e al futuro

**Ready-made, customised and on demand  
We care for the environment and look to the future and products.**

Lo stabilimento Fimet si affaccia direttamente sulla natura.

The Fimet plant overlooks a natural landscape.



# Eco-gestione del ciclo produttivo

Ciclo produttivo che rispetta l'ambiente:  
 1 / Utilizzo di vernici prive di VOCs  
 2 / Efficienza energetica dell'impianto di verniciatura  
 3 / Recupero e riutilizzo delle vernici a polvere

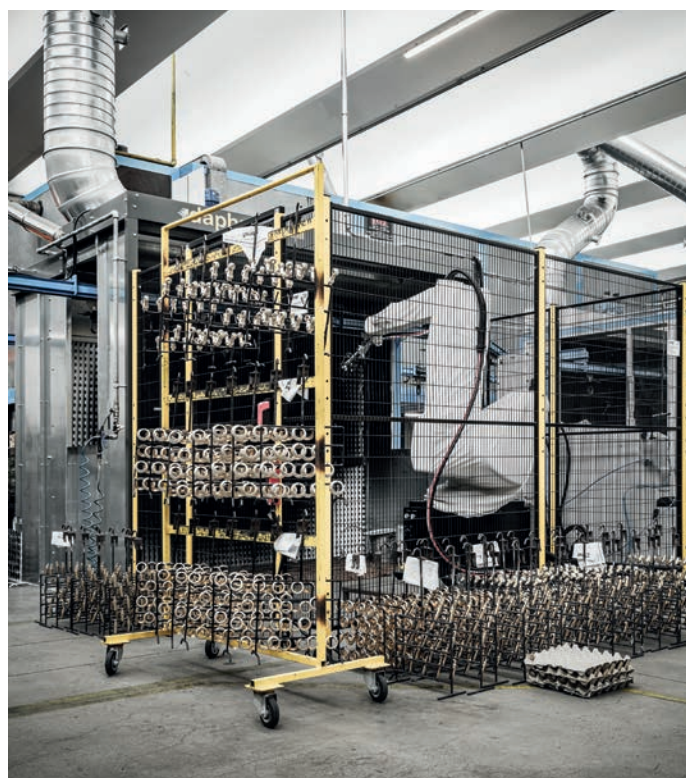

Impianto di verniciatura automatizzato. Automated painting system.



# Eco-management of the production cycle

Environmentally friendly  
production cycle:  
1 / Use of VOC-free paints  
2 / Energy efficiency of  
the painting system  
3 / Recovery and re-use  
of powder paints

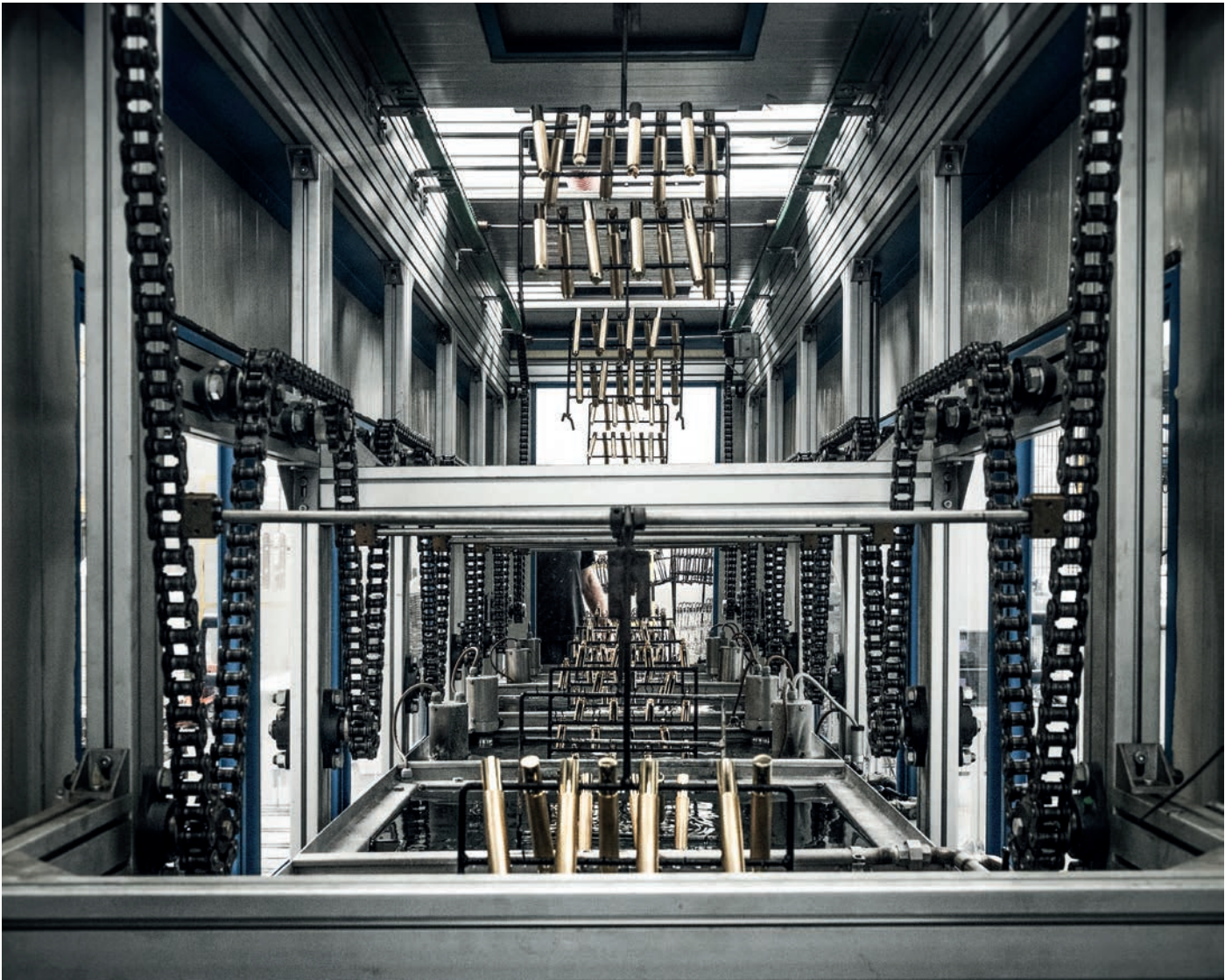

Lavaggio  
ad acqua  
ecosostenibile.

Sustainable  
water washing  
system.



#### CLAUDIO DI PALMA

<sup>IT</sup> Consegue la Laurea Magistrale in Disegno Industriale presso l'Università della Campania, trascorrendo un anno a Bruxelles come studente Erasmus presso l'ENSAC La Cambre, scuola di design fondata nel 1926 da Henry van de Velde. Dal 2019 lavora ad Amsterdam come designer indipendente. Ha sviluppato diversi progetti per aziende italiane e internazionali, esponendo prodotti in numerose mostre.

<sup>EN</sup> He holds a Master's degree in Industrial Design from the University of Campania and spent a year in Brussels as an Erasmus student at ENSAC La Cambre, the design school founded by Henry van de Velde in 1926. He has been working as an independent designer in Amsterdam since 2019. He has worked on a number of projects for Italian and international companies and showcased his products at many exhibitions.



#### ENRICO GALLO

<sup>IT</sup> Nato nel basso Polesine, dopo la maturità scientifica si iscrive alla Scuola Italiana Design di Padova dove conosce a pieno la progettazione del prodotto industriale. Durante e dopo il Master sviluppa una serie di componenti per mobili, quali pomoli e maniglie. Attualmente freeLancer lavora, tra le altre, per varie aziende legate alla lavorazione dei metalli.

<sup>EN</sup> He was born in the Polesine region, near Rovigo. After graduating from scientific high school, he enrolled at Scuola Italiana Design in Padua, where he acquired in-depth knowledge of industrial product design. During and after his master's course he developed a number of furniture components such as knobs and handles. He currently works as a freelancer for various metalworking companies, among others.



#### ROBBY CANTARUTTI

<sup>IT</sup> Lo studio Robby Cantarutti and partners fondato da Robby Cantarutti e Francesca Petricich ( marito e moglie) nasce nel 1995 in provincia di Udine. Lo studio delle diverse culture dell'abitare, i cambiamenti del vivere quotidiano, l'analisi dei comportamenti delle varie culture è lo stimolo per la creazione dei loro progetti.

<sup>EN</sup> The Robby Cantarutti and Partners studio was founded by Robby Cantarutti and his wife Francesca Petricich near Udine in 1995. The study of different home cultures and ways of life, the changes affecting daily living, and the analysis of different cultural behaviours is the inspiration behind their projects.



#### FRANCESCO POLARE

<sup>IT</sup> Designer laureato al Politecnico di Milano, da sempre ha assecondato la sua curiosità cimentandosi in differenti settori e convogliando nei suoi progetti le varie esperienze maturate. Libero professionista, vive e lavora a Milano.

<sup>EN</sup> As a graduate designer from the Polytechnic University of Milan, he has always indulged his spirit of inquiry by delving into different sectors and incorporating his various experiences into his projects. He lives and works as a freelancer in Milan.

# About our designer

<sup>IT</sup> Lungo il nostro percorso evolutivo, abbiamo incontrato dei designer italiani ed europei che condividono i nostri valori e arricchiscono le nostre collezioni con la loro creatività e cultura del progetto, permettendoci di sviluppare e realizzare dei prodotti sempre più affascinanti e innovativi.

<sup>EN</sup> Throughout our evolutionary journey, we have met Italian and European designers who share our values and add to our collections through their creativity and design culture. This allows us to develop and create ever more fascinating and innovative products.



**PETR NOVAGUE**

<sup>IT</sup> Si è laureato all'Accademia di Arti, Architettura e Design di Praga. Ha inoltre studiato design industriale presso l'Università di Duisburg Essen in Germania e design dei trasporti presso l'Accademia di Belle Arti e Design di Bratislava. Ha progettato oltre 50 prototipi di vari prodotti: dalla penna o il primissimo smartphone ceco Verzo ad auto e yacht.

<sup>EN</sup> He graduated from the Academy of Arts, Architecture and Design in Prague. He also studied industrial design at the University of Duisburg Essen, Germany, and transport design at the Academy of Fine Arts and Design in Bratislava. He has designed over 50 prototypes for various products, ranging from pens to the very first Czech Verzo smartphone, as well as cars and yachts.



**NICOLA NOVELLETTO**

<sup>IT</sup> Nicola Novelletto, classe 61, vive e lavora a Milano. Ha affiancato all'attività professionale quella didattica presso il Politecnico di Milano e istituti privati. Dal 1993 opera in diversi settori: nautica, oggettistica, gioielleria e orologeria, elettromedicali, rubinetterie, attrezzature sportive, casalinghi, complementi d'arredo, macchinari industriali, packaging e grafica.

<sup>EN</sup> Born in 1961, Nicola Novelletto lives and works in Milan. In addition to his professional activity, he has also taught at the Polytechnic University of Milan and in private schools. Since 1993 he has been working in various sectors, such as the boating industry, home accessories, jewellery and watchmaking, electromedical devices, taps and fittings, sports equipment, household goods, furnishings, industrial machinery, packaging and graphic design.



**FABRIZIO GANDI**

<sup>IT</sup> Nasce a Casto (BS) nel 1953. Si definisce pittore, scultore, designer. Si diploma alla scuola di Brera a Milano nel 1984. La sua vena artistica classica – barocca ci ha aiutato a forgiare idee e perfezionare modelli. Ha lavorato per molte aziende del settore dell'ottone e dell'alluminio creando modelli unici nel loro genere raccogliendo consensi e plausi da tutto il mondo.

<sup>EN</sup> Born in Casto, Brescia in 1953. He defines himself as a painter, sculptor and designer. He graduated in 1984 from Brera Academy in Milan. His classical-baroque artistic flair has helped us to shape ideas and perfect models. He has worked for many companies in the brass and aluminium industry, creating unique products and garnering worldwide acclaim and praise.



**ALBANIA**  
**ARABIA SAUDITA**  
**ARMENIA**  
**AUSTRIA**  
**AZERBAIJAN**  
**BAHRAIN**  
**BELGIO**  
**BIELORUSSIA**  
**BOSNIA ERZEGOVINA**  
**BULGARIA**  
**CINA (HK)**  
**CIPRO**  
**COLOMBIA**  
**CROAZIA**  
**FRANCIA**  
**GERMANIA**  
**GEORGIA**  
**GRECIA**  
**IRLANDA**  
**ISRAELE**  
**ITALIA**  
**KOSOVO**  
**KUWAIT**  
**LETTONIA**  
**LIBANO**  
**LITUANIA**  
**LUSSEMBURGO**

**MACEDONIA DEL NORD**  
**MALTA**  
**MAROCCO**  
**MOLDAVIA**  
**MONTENEGRO**  
**OMAN**  
**POLONIA**  
**PAESI BASSI**  
**PAKISTAN**  
**QATAR**  
**REP. CECA**  
**ROMANIA**  
**RUSSIA**  
**SERBIA**  
**SLOVACCHIA**  
**SLOVENIA**  
**SPAGNA**  
**SUDAFRICA**  
**TURCHIA**  
**UAE**  
**UCRAINA**  
**UNGHERIA**  
**USA**  
**UK**  
**UZBEKISTAN**  
**VENEZUELA**

# Our world



<sup>IT</sup> La qualità, l'innovazione e il design Fimet sono apprezzati in oltre 50 paesi nel mondo. Un traguardo che ci rende orgogliosi e ci spinge ad aprire nuove prospettive nelle soluzioni e nei servizi, dando sempre il meglio di noi stessi: in tutto quello che facciamo, ogni giorno.

<sup>EN</sup> Fimet products are appreciated for their quality, innovation and design in more than 50 countries around the world. We are proud of our achievements. They motivate us to keep pushing the boundaries with our solutions and services, and to be at the top of our game in all that we do on a day-to-day basis.



# Eco packaging

<sup>IT</sup> Le confezioni Fimet sono realizzate con cartone 100% riciclabile e certificato FSC (Forest Stewardship Council): un'ulteriore dimostrazione del nostro impegno nei confronti della sostenibilità.

<sup>EN</sup> Fimet packaging is made from 100% recyclable FSC (Forest Stewardship Council) certified cardboard. This is further evidence of our ongoing commitment to sustainability.





**ESPOSITORE.MURO.BG**

Espositore a terra.  
*Floor display.*

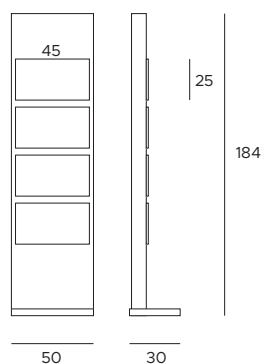

**ESPOSITORE.GIREVOLE.BG**

Espositore a terra girevole su due lati.  
*Two-sided floor rotating display.*

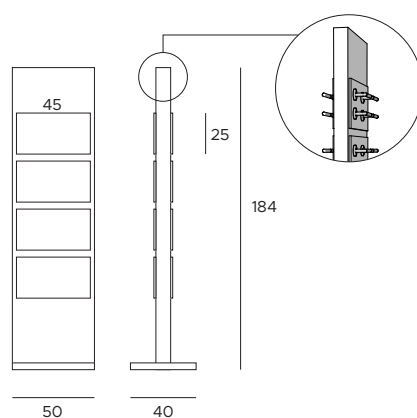

**ESPOSITORE.COLONNA.GIREVOLE**

Espositore a terra girevole.  
*Four-sided floor rotating display.*

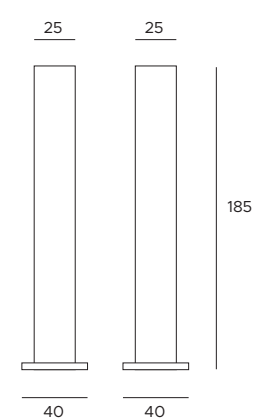

# Our displays

<sup>IT</sup> Abbiamo realizzato una scelta completa di espositori da terra, da parete e da banco, per mettere in mostra i nostri prodotti ottimizzando lo spazio disponibile negli showroom: contattateci per richiederli.

<sup>EN</sup> We have developed a full range of floor, wall and counter displays to showcase our products and maximise retail space. Contact us to request them.



**ESPO.50X100.BIANCO**

Espositore a muro.  
*Wall display.*



**ESPO.50X100.NERO**



**ESPOSITORE.MAN.NERO**

Espositore da banco girevole.  
*Three-sided counter rotating display.*



**ESPOSITORE.BANCO.GRIGIO**

Espositore da banco.  
*Two-sided counter display.*

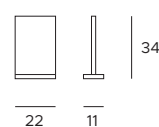
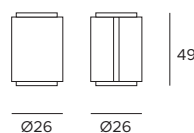
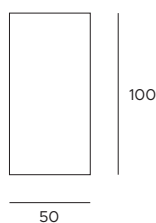

# Metal base



**IT** Montaggio semplice e sicuro grazie all'innovativo centratore per il ferro quadro, con in più la garanzia della base in metallo, abbinabile sia alla copertina tonda che a quella quadrata. La base, dotata di fori per viti maschio / femmina con interasse 38 mm, è disponibile con bussole sporgenti oppure rasata. La copertina in metallo viene fornita montata sull'impugnatura tramite una molla testata per 200.000 aperture. Il tutto viene mantenuto in posizione dai grani di fissaggio presenti sulle impugnature.

**EN** An innovative square spindle adapter and a metal base that can be combined with both round and square covers, make installation easy and safe. The base is available with or without bulging sleeves and is drilled for 38-mm screw hole spacing male/female screws.

A spring tested to open 200,000 times secures the metal cover to the handle. Grub screws on the handles hold everything in place.



# Plastic base



**IT** Basta un “clic” e la base in plastica si incastra a pressione sulla rosetta, restando stabilmente in posizione grazie ai grani di fissaggio sulle impugnature e alla molla garantita per 200.000 aperture. Disponibile in versione tonda o quadrata, è dotata di fori per viti maschio / femmina con interasse 38 mm. L'assemblaggio è reso ancora più facile dallo speciale centratore per il ferro quadro.

**EN** The plastic base snaps onto the cover with a single ‘click’. It is held firmly in place by the grub screws on the handles and the spring, which is guaranteed to open 200,000 times. It is available in a round or square version and is drilled for 38-mm screw hole spacing male/female screws. The special square spindle adapter makes installation even easier.





**FNO**  
 nero opaco RAL 9005  
*opaque black RAL 9005*



**FBO**  
 bianco opaco RAL 9016  
*opaque white RAL 9016*



**F41**  
 bianco opaco RAL 9010  
*opaque white RAL 9010*



**FBL**  
 bianco lucido RAL 9010  
*polished white RAL 9010*



**F020**  
 effetto ottone satinato opaco  
*opaque satin brass effect*



**F01**  
 ottone lucido  
*polished brass*



**F18**  
 PVD giallo lucido  
*polished yellow PVD*



**F02**  
 ottone satinato  
*satin brass*



**F04**  
 cromo lucido  
*polished chrome*



**F21**  
 nickel lucido  
*polished nickel*



**F16**  
 effetto cromo satinato  
*satin chrome effect*



**F54**  
 eff. nickel sat. vernic. op.  
*op. satin nickel effect*



**F15**  
 antracite  
*anthracite*

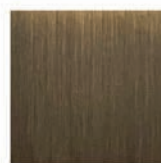

**F03**  
 bronzo graffiato lucido  
*shiny satin bronze*



**F43**  
 bronzo graffiato opaco  
*opaque satin bronze*



**F05**  
 cromo satinato  
*satin chrome*

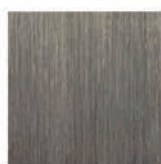

**F20**  
 nickel satinato  
*satin nickel*



**F90**  
 effetto bourbon  
*bourbon effect*

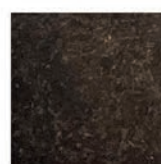

**F23**  
 bronzo antico  
*aged bronzed brass*



**F45**  
 ferro antico  
*antique iron*

# Finishes

<sup>IT</sup> Tutti i prodotti Fimet possono essere rifiniti nel reparto di verniciatura interno, in una gamma completa di tonalità, oppure sottoposti a un trattamento di cromatura o bronzatura, effettuato da esperti laboratori artigiani, per rispondere a ogni esigenza stilistica e gusto estetico.

<sup>EN</sup> All Fimet products are finished in a full range of colours in our own paint shop, or can also be chrome-plated or bronze-plated in specialist workshops to suit any style and aesthetic requirement.





# Secret

**Un sistema  
di chiusura  
rivoluzionario  
per l'interior  
design.**

**A revolutionary  
closing system  
for the world of  
interior design.**

# Minimale, funzionale, semplice.

Minimal,  
functional,  
simple.



<sup>IT</sup> Silenziosità e fluidità di movimento sono le caratteristiche principali di Secret. L'assenza di una maniglia dall'impugnatura classica esalta il design.

Secret è una reale esperienza tattile, ma anche innovazione. Un concetto in attesa di essere scoperto: il sistema di comando di chiusura è invisibile, totalmente integrato nel design. Less is more.

<sup>EN</sup> Silence and fluidity of movement are the main features of Secret. The absence of a classic handle boosts the design.

Secret is a real tactile experience and innovation. A concept waiting to be discovered: the closing control system is invisible, totally integrated into the design. Less is more.

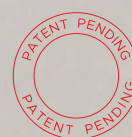

<sup>IT</sup> Dispositivo magnetico. Sistema brevettato di chiusura con dispositivo magnetico regolabile senza contatto e con riferma meccanica azionata dal sistema invisibile.

<sup>EN</sup> Magnetic device. Patented contactless magnetic locking system with adjustable strength and deadbolt operated by the concealed system.

	F020	F90	FNO	FBO
Finiture disponibili Available finishes	effetto ottone satinato opaco opaque satin brass effect	effetto bourbon bourbon effect	nero opaco opaque black	bianco opaco opaque white

# Secret 807

alluminio / aluminum



**807.250W**

**807.700W**

**807.1100W**

Coppia maniglione con sistema di chiusura.

*Pull handles pair with closing system.*

**Serratura magnetica abbinabile**  
*Matching magnetic lock*

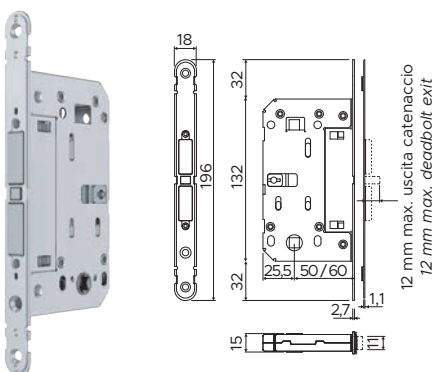

**807.250**

**807.700**

**807.1100**

Coppia maniglione senza sistema di chiusura.

*Pull handles pair without closing system.*

**Serratura magnetica abbinabile**  
*Matching magnetic lock*

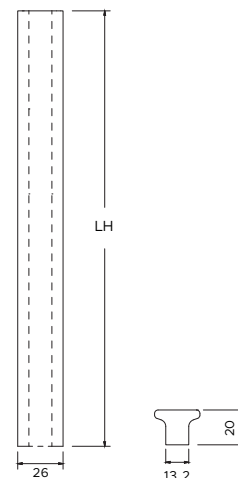
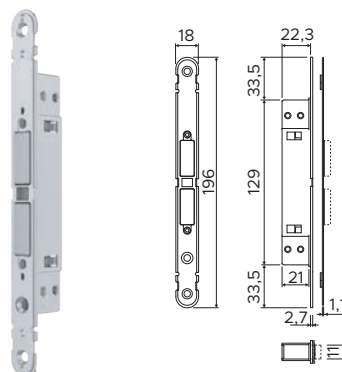

**LH**

250 mm

700 mm

1100 mm

**Entrata / Backset**

50 - 60 mm

**Versioni / Versions**

Passante

privacy bagno / WC

**Frontale / Front plate**

196x18x3,8 mm

**Quadro / Square**

bagno / WC 8 mm

**Interasse / Axis**

bagno / WC 96 mm

**Contropiastre regolabili per porte in legno.**

*Adjustable striking plates for wooden doors.*

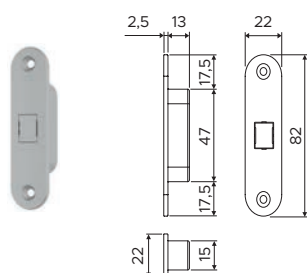

**Contropiastre regolabili per profili in alluminio.**

*Adjustable striking plates for aluminum frames.*

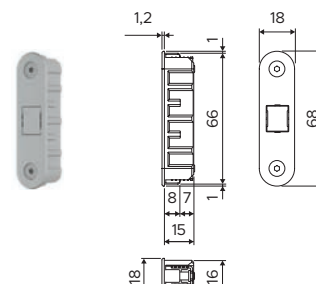



# Moderno

Modern





# New York

design Robby Cantarutti



# New York 1215

zama / zinc



**1215/264**

PZ BB WC

Maniglia con rosetta clip con sottorosetta in plastica.  
*Handle with clip rose and PVC under-construction.*

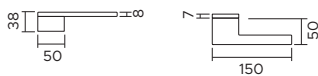

**1215/210**

PZ BB WC

Maniglia con placca.  
*Handle with plate.*

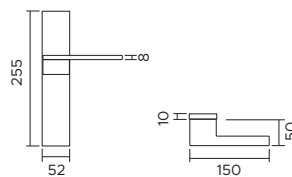

**F04**

cromo lucido  
*polished chrome*



**F05**

cromo satinato  
*satin chrome*



**F020**

effetto ottone satinato opaco  
*opaque satin brass effect*



**F15**

antracite  
*anthracite*



**FNO**

nero opaco  
*opaque black*



# Futura

design Fimet



# Futura 1332

zama / zinc



## 1332/277 BB

Maniglia con rosetta clip con sottorosetta in plastica. Bocchetta foro chiave.

*Handle with clip rose and PVC under-construction. Escutcheon with key hole.*

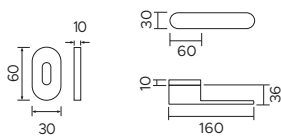

## 1332/277 PZ

Maniglia con rosetta clip con sottorosetta in plastica. Bocchetta foro cilindro.

*Handle with clip rose and PVC under-construction. Escutcheon with cylinder hole.*

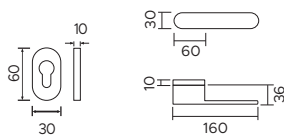

## 1332/277 WC317

Maniglia con rosetta clip con sottorosetta in plastica. Bocchetta foro WC.

*Handle with clip rose and PVC under-construction. Escutcheon with WC hole.*

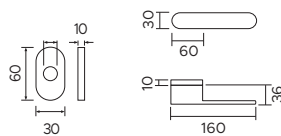

## 1332 DK

Maniglia anta ribalta.

*Tilt and turn handle.*

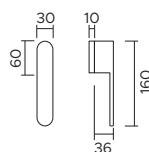

## F05

cromo satinato  
*satin chrome*



## F020

effetto ottone satinato opaco  
*opaque satin brass effect*



## F90

effetto bourbon  
*bourbon effect*



## F15

antracite  
*anthracite*



## FNO

nero opaco  
*opaque black*



## FBO

bianco opaco  
*opaque white*



# Infinity

design Petr Novague



# Infinity 1501

zama / zinc

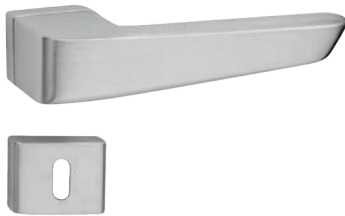

## 1501/239 BB

Maniglia con rosetta,  
sottorosetta in metallo.  
Bocchetta foro chiave.

*Handle with rose,  
metal under-construction.  
Escutcheon with key hole.*

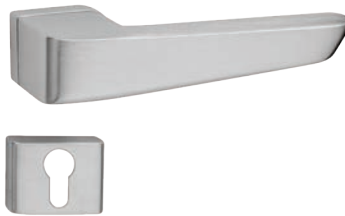
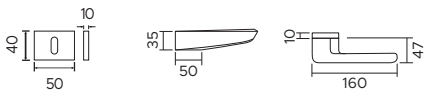

## 1501/239 PZ

Maniglia con rosetta,  
Sottorosetta in metallo.  
Bocchetta foro cilindro.

*Handle with rose,  
Metal under-construction.  
Escutcheon with cylinder hole.*

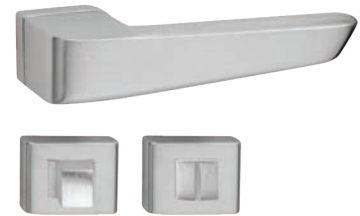
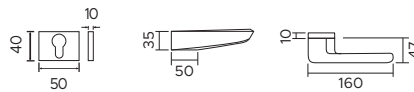

## 1501/239 WC302

Maniglia con rosetta,  
Sottorosetta in metallo.  
Bocchetta foro WC.

*Handle with rose,  
Metal under-construction.  
Escutcheon with WC hole.*

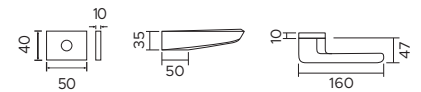

## F05

Cromo satinato  
*satin chrome*



## F20

Nickel satinato  
*satin nickel*



## FNO

Nero opaco  
*opaque black*



# Ultima

design Petr Novague



# Ultima 1502

zama / zinc



## 1502/239 BB

Maniglia con rosetta,  
sottorosetta in metallo.  
Bocchetta foro chiave.

*Handle with rose,  
metal under-construction.  
Escutcheon with key hole.*

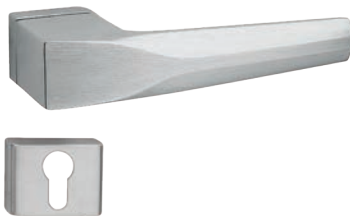
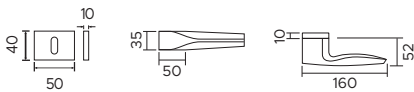

## 1502/239 PZ

Maniglia con rosetta,  
Sottorosetta in metallo.  
Bocchetta foro cilindro.

*Handle with rose,  
Metal under-construction.  
Escutcheon with cylinder hole.*

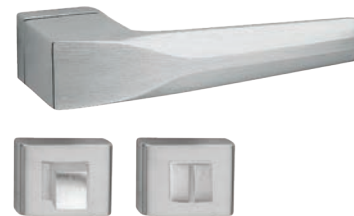
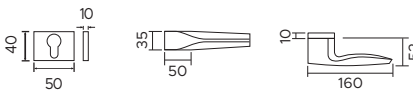

## 1502/239 WC302

Maniglia con rosetta,  
Sottorosetta in metallo.  
Bocchetta foro WC.

*Handle with rose,  
Metal under-construction.  
Escutcheon with WC hole.*

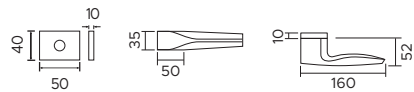

## F05

Cromo satinato  
*satin chrome*



## F20

Nickel satinato  
*satin nickel*



## FNO

Nero opaco  
*opaque black*







# Onda

design Claudio Di Palma

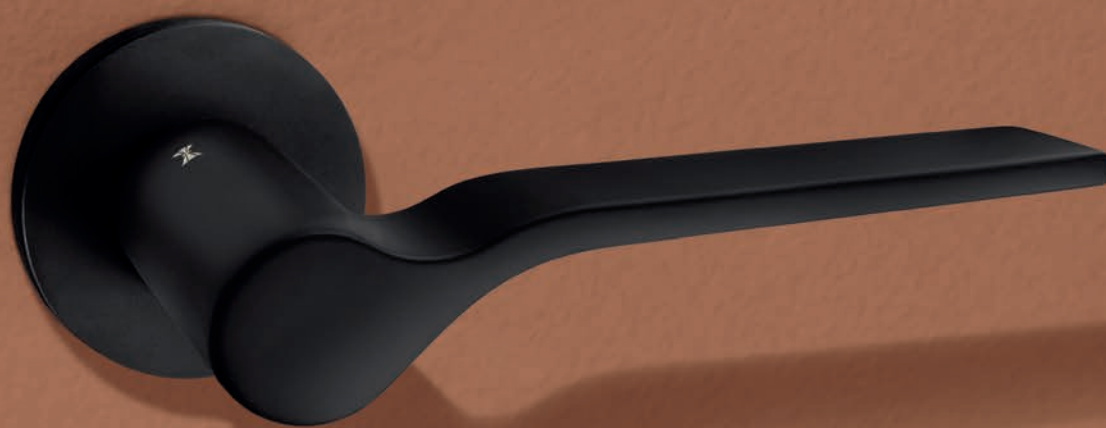

# Onda 1230

zama / zinc



**1230/208**



Maniglia con rosetta, sottorosetta in metallo.  
*Handle with rose, metal under-construction.*

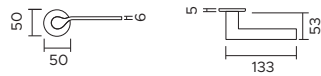

**1230/275R**

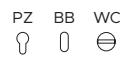

Maniglia con placca.  
*Handle with plate.*

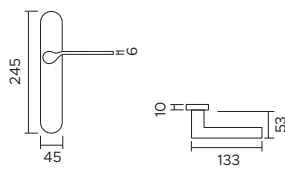

**1230 DK**

Maniglia anta ribalta.  
*Tilt and turn handle.*

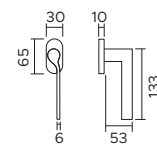

**F04**

Cromo lucido  
*polished chrome*



**F05**

Cromo satinato  
*satin chrome*



**F020**

Effetto ottone satinato opaco  
*opaque satin brass effect*



**F90**

Effetto bourbon  
*bourbon effect*



**FNO**

Nero opaco  
*opaque black*



**FBO**

Bianco opaco  
*opaque white*



più finiture a richiesta / more finishes upon request

# Onda

design Claudio Di Palma

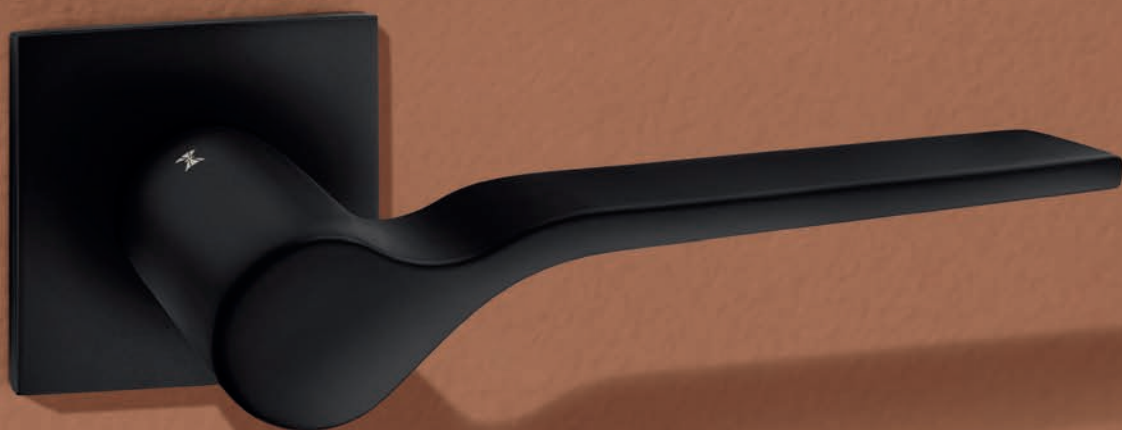

# Onda 1230

zama / zinc

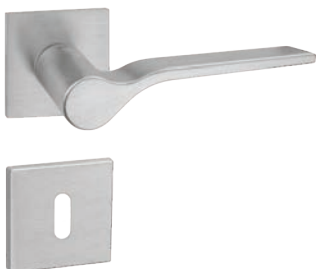

**1230/213**



Maniglia con rosetta, sottorosetta in metallo.  
*Handle with rose, metal under-construction.*

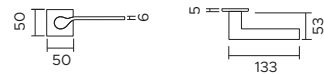

**1230/209**

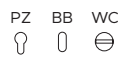

Maniglia con placca.  
*Handle with plate.*

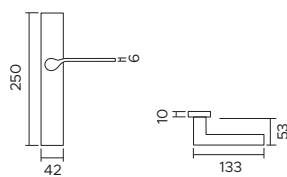

**1230 DKR**

Maniglia anta ribalta.  
*Tilt and turn handle.*

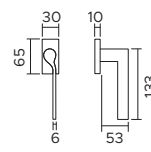

**F04**

Cromo lucido  
*polished chrome*



**F05**

Cromo satinato  
*satin chrome*



**F020**

Effetto ottone satinato opaco  
*opaque satin brass effect*



**F90**

Effetto bourbon  
*bourbon effect*



**FNO**

Nero opaco  
*opaque black*



**FBO**

Bianco opaco  
*opaque white*



più finiture a richiesta / more finishes upon request





# Alicia

design Francesco Polare



# Alicia 1220

zama / zinc



**1220/208**

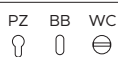

Maniglia con rosetta, sottorosetta in metallo.  
Handle with rose, metal under-construction.

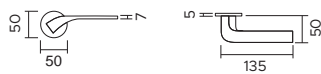

**1220/275R**

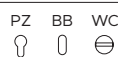

Maniglia con placca.  
Handle with plate.

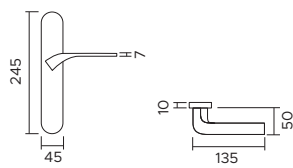

**1220 DK**

Maniglia anta ribalta.  
Tilt and turn handle.

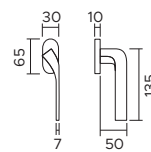

**F04**

Cromo lucido  
polished chrome



**F05**

Cromo satinato  
satin chrome



**F020**

Effetto ottone satinato opaco  
opaque satin brass effect



**F90**

Effetto bourbon  
bourbon effect



**F54**

Effetto nickel satinato verniciato op.  
opaque satin nickel effect



**F15**

Antracite  
anthracite



**FNO**

Nero opaco  
opaque black



**FBO**

Bianco opaco  
opaque white



più finiture a richiesta / more finishes upon request

# Alicia

design Francesco Polare



# Alicia 1220

zama / zinc



**1220/213**

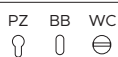

Maniglia con rosetta, sottorosetta in metallo.  
*Handle with rose, metal under-construction.*

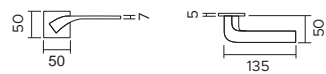

**1220/209**

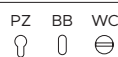

Maniglia con placca.  
*Handle with plate.*

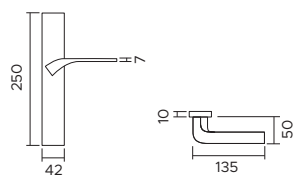

**1220 DKR**

Maniglia anta ribalta.  
*Tilt and turn handle.*

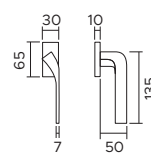

**F04**

Cromo lucido  
*polished chrome*



**F05**

Cromo satinato  
*satin chrome*



**F020**

Effetto ottone satinato opaco  
*opaque satin brass effect*



**F90**

Effetto bourbon  
*bourbon effect*



**F54**

Effetto nickel satinato verniciato op.  
*opaque satin nickel effect*



**F15**

Antracite  
*anthracite*



**FNO**

Nero opaco  
*opaque black*



**FBO**

Bianco opaco  
*opaque white*



più finiture a richiesta / more finishes upon request

# Ico

design Francesco Polare



# Ico 1225

zama / zinc



**1225/208**



Maniglia con rosetta, sottorosetta in metallo.  
Handle with rose, metal under-construction.

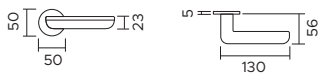

**1225/275R**

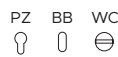

Maniglia con placca.  
Handle with plate.

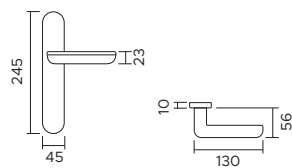

**1225 DK**

Maniglia anta ribalta.  
Tilt and turn handle.

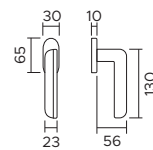

**F04**

Cromo lucido  
polished chrome



**F05**

Cromo satinato  
satin chrome



**F020**

Effetto ottone satinato opaco  
opaque satin brass effect



**F90**

Effetto bourbon  
bourbon effect



**F54**

Effetto nickel satinato verniciato op.  
opaque satin nickel effect



**F15**

Antracite  
anthracite



**FNO**

Nero opaco  
opaque black



**FBO**

Bianco opaco  
opaque white



più finiture a richiesta / more finishes upon request

# Ico

design Francesco Polare



# Ico 1225

zama / zinc

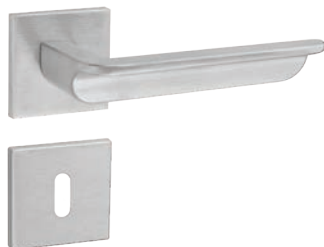

**1225/213**



Maniglia con rosetta, sottorosetta in metallo.  
*Handle with rose, metal under-construction.*

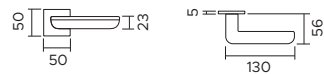

**1225/211B**



Maniglia con rosetta clip con sottorosetta in plastica.  
*Handle with clip rose and PVC under-construction.*

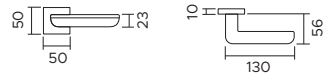

**1225/209**

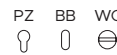

Maniglia con placca.  
*Handle with plate.*

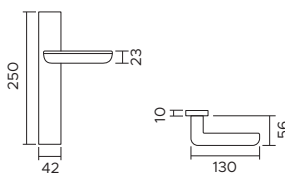

**1225 DKR**

Maniglia anta ribalta.  
*Tilt and turn handle.*

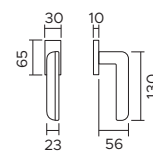

**F04**

Cromo lucido  
*polished chrome*



**F05**

Cromo satinato  
*satin chrome*



**F020**

Effetto ottone satinato opaco  
*opaque satin brass effect*



**F90**

Effetto bourbon  
*bourbon effect*



**F54**

Effetto nickel satinato verniciato op.  
*opaque satin nickel effect*



**F15**

Antracite  
*anthracite*



**FNO**

Nero opaco  
*opaque black*



**FBO**

Bianco opaco  
*opaque white*



più finiture a richiesta / more finishes upon request





# Punto

design Robby Cantarutti



# Punto 1205

zama / zinc



**1205/208**



Maniglia con rosetta, sottorosetta in metallo.  
*Handle with rose, metal under-construction.*

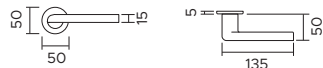

**1205/275R**



Maniglia con placca.  
*Handle with plate.*

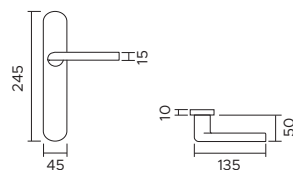

**1205 DK**

Maniglia anta ribalta.  
*Tilt and turn handle.*

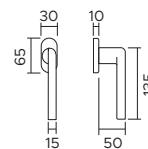

**F04**

cromo lucido  
*polished chrome*



**F05**

cromo satinato  
*satin chrome*



**F020**

effetto ottone satinato opaco  
*opaque satin brass effect*



**F90**

effetto bourbon  
*bourbon effect*



**F54**

effetto nickel satinato verniciato op.  
*opaque satin nickel effect*



**F15**

antracite  
*anthracite*



**FNO**

nero opaco  
*opaque black*



**FBO**

bianco opaco  
*opaque white*



**F43**

bronzo graffiato opaco  
*opaque satin bronze*



più finiture a richiesta / more finishes upon request

# Punto

design Robby Cantarutti



# Punto 1205

zama / zinc



**1205/213**



Maniglia con rosetta, sottorosetta in metallo.

*Handle with rose, metal under-construction.*

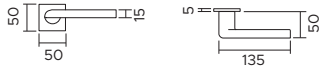

**1205/209**



Maniglia con placca.  
*Handle with plate.*

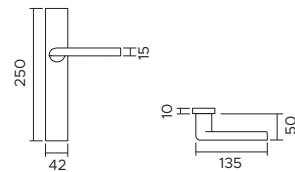

**1205 DKR**

Maniglia anta ribalta.  
*Tilt and turn handle.*

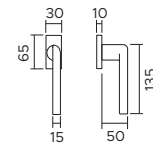

**F04**

Cromo lucido  
*polished chrome*



**F05**

Cromo satinato  
*satin chrome*

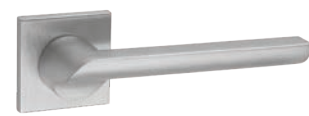

**F020**

effetto ottone satinato opaco  
*opaque satin brass effect*

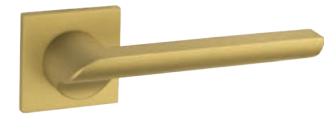

**F90**

effetto bourbon  
*bourbon effect*

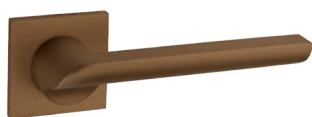

**F54**

effetto nickel satinato verniciato op.  
*opaque satin nickel effect*

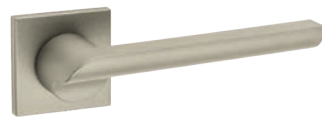

**F15**

antracite  
*anthracite*

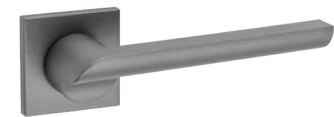

**FNO**

nero opaco  
*opaque black*



**FBO**

bianco opaco  
*opaque white*



**F43**

bronzo graffiato opaco  
*opaque satin bronze*



più finiture a richiesta / more finishes upon request

# Origami

design Robby Cantarutti

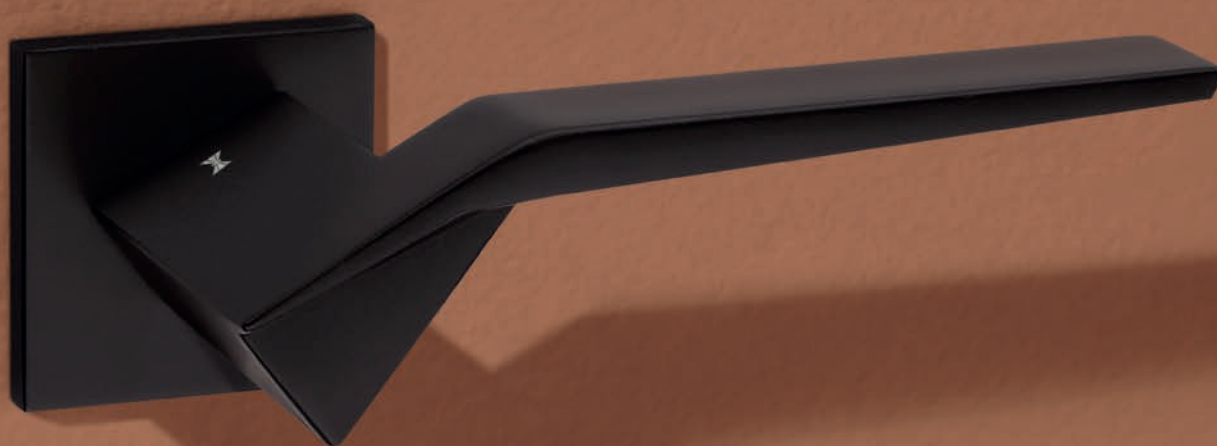

# Origami 1210

zama / zinc



**1210/213**



Maniglia con rosetta,  
sottorosetta in metallo.  
*Handle with rose,  
metal under-construction.*

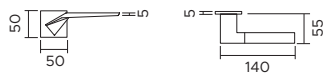

**1210/209**

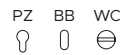

Maniglia con placca.  
*Handle with plate.*

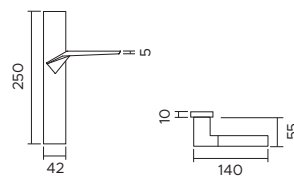

**1210 DKR**

Maniglia anta ribalta.  
*Tilt and turn handle.*

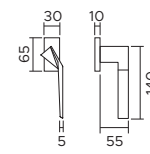

**F04**

Cromo lucido  
*polished chrome*



**F05**

Cromo satinato  
*satin chrome*



**F20**

Nickel satinato  
*satin nickel*



**F020**

Effetto ottone satinato opaco  
*opaque satin brass effect*



**F15**

Antracite  
*anthracite*



**FNO**

Nero opaco  
*opaque black*



più finiture a richiesta / more finishes upon request

# Plana

design Nicola Novelletto



# Plana 1200

zama / zinc



**1200/208**



Maniglia con rosetta, sottorosetta in metallo.  
Handle with rose, metal under-construction.

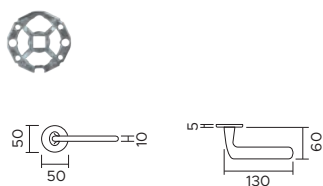

**1200/205**



Maniglia con placca.  
Handle with plate.

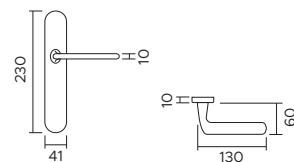

**1200 DK**

Maniglia anta ribalta.  
Tilt and turn handle.

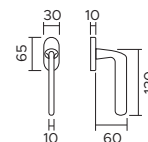

**F01**

ottone lucido  
polished brass



**F04**

cromo lucido  
polished chrome



**F05**

cromo satinato  
satin chrome



**F020**

effetto ottone satinato opaco  
opaque satin brass effect



**F54**

effetto nickel satinato verniciato op.  
opaque satin nickel effect



**F15**

antracite  
anthracite



**F90**

effetto bourbon  
bourbon effect



**FNO**

nero opaco  
opaque black



**F43**

bronzo graffiato opaco  
opaque satin bronze



più finiture a richiesta / more finishes upon request

# Eva



# Eva 1445

ottone / brass



**1445/208**



Maniglia con rosetta,  
sottorosea in metallo.  
*Handle with rose,  
metal under-construction.*

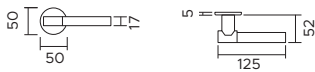

**1445/275R**

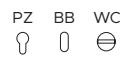

Maniglia con placca.  
*Handle with plate.*

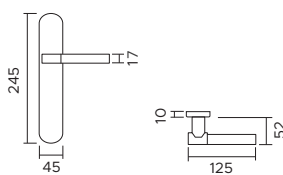

**1445 DK**

Maniglia anta ribalta.  
*Tilt and turn handle.*

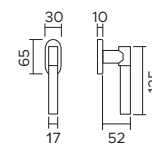

**F04**

Cromo lucido  
*polished chrome*



**F01**

Ottone lucido  
*polished brass*



**F02**

Ottone satinato  
*satın brass*



**F20**

Nickel satinato  
*satın nickel*



**FNO**

Nero opaco  
*opaque black*



**F43**

Bronzo graffiato opaco  
*opaque satın bronze*



più finiture a richiesta / more finishes upon request

# Cloè

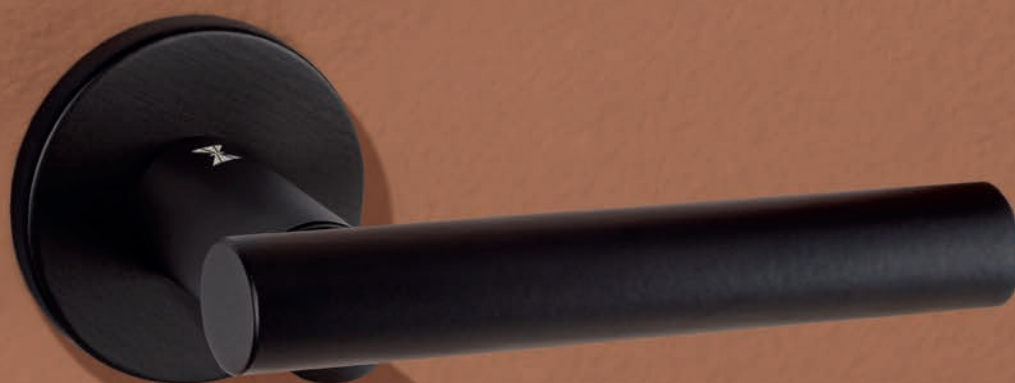

# Cloè 1171

ottone / brass



**1171/208**



Maniglia con rosetta,  
sottorosea in metallo.  
*Handle with rose,  
metal under-construction.*

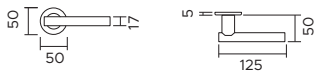

**1171/275R**

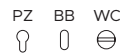

Maniglia con placca.  
*Handle with plate.*

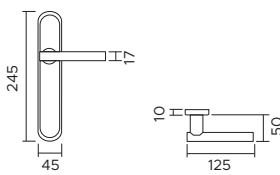

**1171 DK**

Maniglia anta ribalta.  
*Tilt and turn handle.*

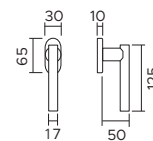

**F04**

Cromo lucido  
*polished chrome*



**F01**

Ottone lucido  
*polished brass*



**F02**

Ottone satinato  
*satın brass*



**F05**

Cromo satinato  
*satın chrome*



**FNO**

Nero opaco  
*opaque black*



più finiture a richiesta / more finishes upon request

# Pura

design Enrico Gallo

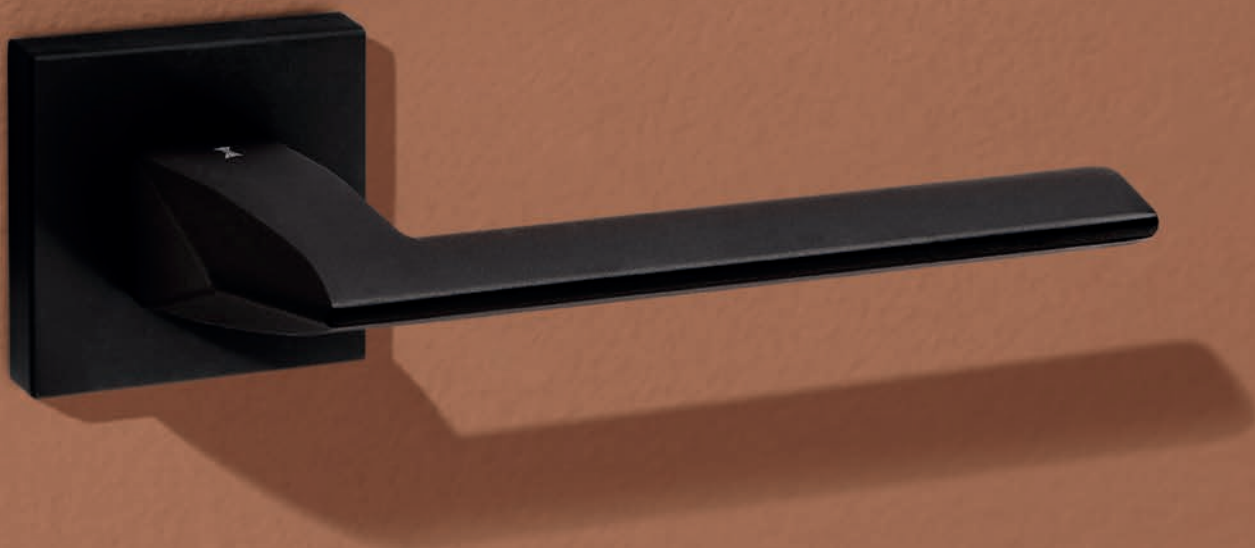

# Pura 1352

zama / zinc

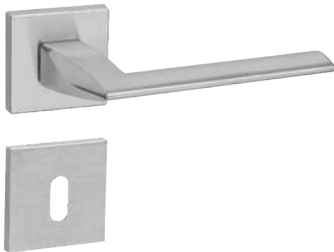

**1352/213**



Maniglia con rosetta, sottorosetta in metallo.  
*Handle with rose, metal under-construction.*

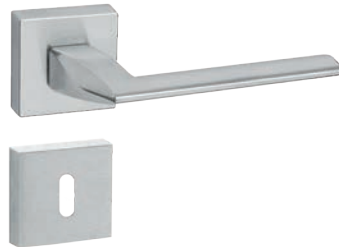
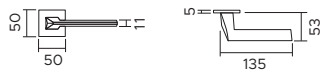

**1352/201**

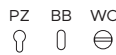

Maniglia con rosetta clip con sottorosetta in plastica.  
*Handle with clip rose and PVC under-construction.*

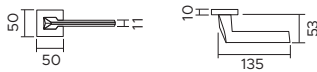

**1352/209**

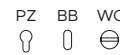

Maniglia con placca.  
*Handle with plate.*

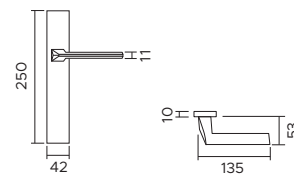

**1352 DKR**

Maniglia anta ribalta.  
*Tilt and turn handle.*

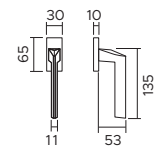

**F04**

Cromo lucido  
*polished chrome*



**F05**

Cromo satinato  
*satin chrome*



**F90**

Effetto bourbon  
*bourbon effect*



**F54**

Effetto nickel sat. verniciato op.  
*opaque satin nickel effect*



**F15**

Antracite  
*anthracite*



**FNO**

Nero opaco  
*opaque black*



**F43**

Bronzo graffiato opaco  
*opaque satin bronze*



più finiture a richiesta / more finishes upon request

# Corsa

design Enrico Gallo



# Corsa 1354

zama / zinc



**1354/208**



Maniglia con rosetta, sottorosetta in metallo.  
*Handle with rose, metal under-construction.*

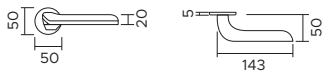

**1354/232**



Maniglia con rosetta clip e sottorosetta in plastica.  
*Handle with clip rose and PVC under-construction.*

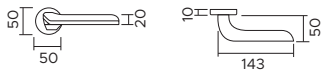

**1354/205**

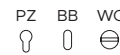

Maniglia con placca.  
*Handle with plate.*

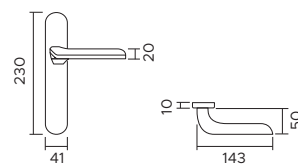

**1354 DK**

Maniglia anta ribalta.  
*Tilt and turn handle.*

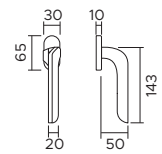

**F04**

cromo lucido  
*polished chrome*



**F05**

cromo satinato  
*satin chrome*



**F20**

nickel satinato  
*satin nickel*



**F15**

antracite  
*anthracite*



**FNO**

nero opaco  
*opaque black*



**FBO**

bianco opaco  
*opaque white*



più finiture a richiesta / more finishes upon request

# Corsa

design Enrico Gallo



# Corsa 1354

zama / zinc

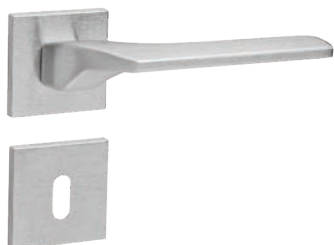

**1354/213**

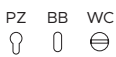

Maniglia con rosetta, sottorosetta in metallo.  
*Handle with rose, metal under-construction.*

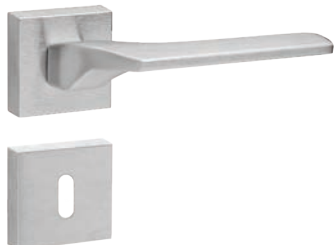
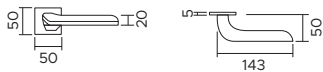

**1354/201**



Maniglia con rosetta clip con sottorosetta in plastica.  
*Handle with clip rose and PVC under-construction.*

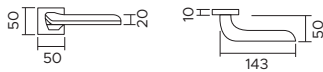

**1354/209**

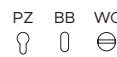

Maniglia con placca.  
*Handle with plate.*

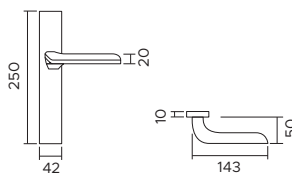

**1354 DKR**

Maniglia anta ribalta.  
*Tilt and turn handle.*

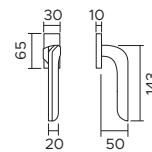

**F04**

cromo lucido  
*polished chrome*



**F05**

cromo satinato  
*satin chrome*



**F20**

nickel satinato  
*satin nickel*



**F15**

antracite  
*anthracite*



**FNO**

nero opaco  
*opaque black*



**FBO**

bianco opaco  
*opaque white*



più finiture a richiesta / more finishes upon request

# Prisma

design Enrico Gallo



# Prisma 1351

zama / zinc

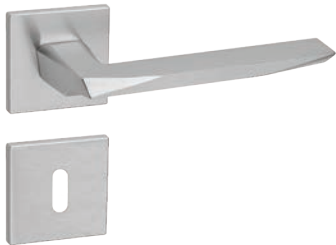

**1351/213**



Maniglia con rosetta, sottorosetta in metallo.  
*Handle with rose, metal under-construction.*

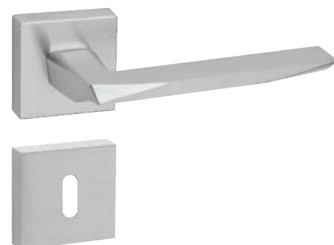
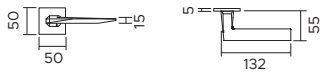

**1351/201**



Maniglia con rosetta clip con sottorosetta in plastica.  
*Handle with clip rose and PVC under-construction.*

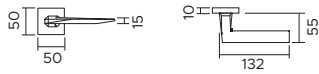

**1351/209**

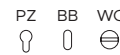

Maniglia con placca.  
*Handle with plate.*

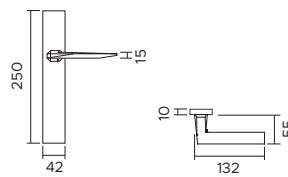

**1351 DKR**

Maniglia anta ribalta.  
*Tilt and turn handle.*

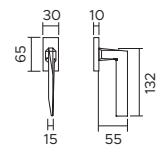

**F04**

cromo lucido  
*polished chrome*



**F05**

cromo satinato  
*satin chrome*



**F15**

antracite  
*anthracite*



**FNO**

nero opaco  
*opaque black*



più finiture a richiesta / more finishes upon request

# Italia

design Enrico Gallo



# Italia 1353

zama / zinc

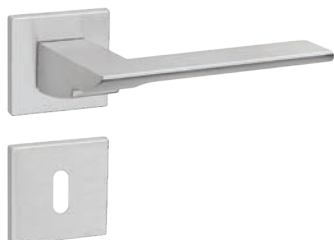

**1353/213**

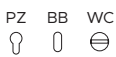

Maniglia con rosetta, sottorosetta in metallo.  
*Handle with rose, metal under-construction.*

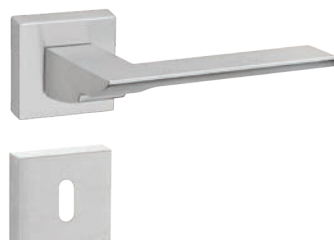
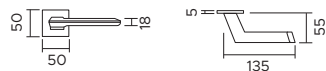

**1353/201**



Maniglia con rosetta clip con sottorosetta in plastica.  
*Handle with clip rose and PVC under-construction.*

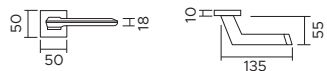

**1353/209**

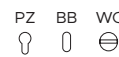

Maniglia con placca.  
*Handle with plate.*

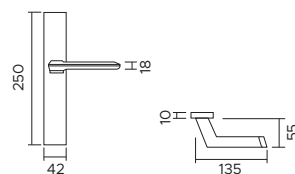

**1353 DKR**

Maniglia anta ribalta.  
*Tilt and turn handle.*

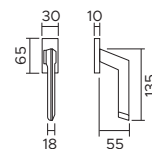

**F04**

cromo lucido  
*polished chrome*



**F05**

cromo satinato  
*satin chrome*

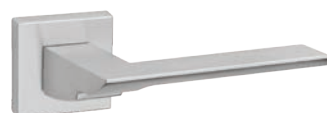

**F20**

nickel satinato  
*satin nickel*

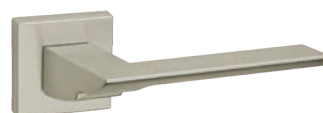

**F15**

antracite  
*anthracite*



**FNO**

nero opaco  
*opaque black*



più finiture a richiesta / more finishes upon request

# Flake

design Enrico Gallo



# Flake 1355

zama / zinc

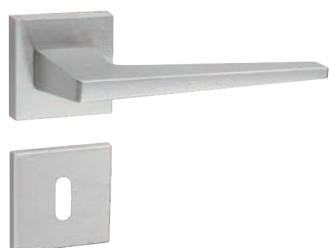

**1355/213**



Maniglia con rosetta, sottorosetta in metallo.  
*Handle with rose, metal under-construction.*

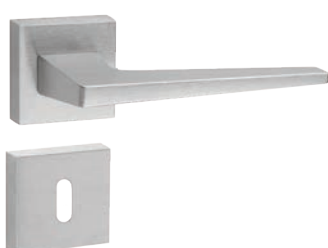
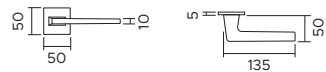

**1355/201**



Maniglia con rosetta clip con sottorosetta in plastica.  
*Handle with clip rose and PVC under-construction.*

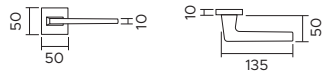

**1355/209**

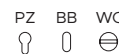

Maniglia con placca.  
*Handle with plate.*

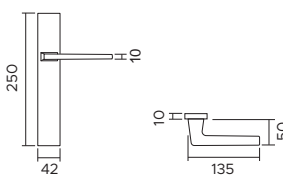

**1355 DKR**

Maniglia anta ribalta.  
*Tilt and turn handle.*

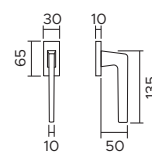

**F04**

Cromo lucido  
*polished chrome*



**F05**

Cromo satinato  
*satin chrome*



**F54**

Effetto nickel satinato verniciato opaco  
*opaque satin nickel effect*



**F15**

Antracite  
*anthracite*



**FNO**

Nero opaco  
*opaque black*



**F43**

Bronzo graffiato opaco  
*opaque satin bronze*



più finiture a richiesta / more finishes upon request

# Adele



# Adele 1239

zama / zinc



**1239/208**

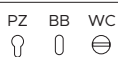

Maniglia con rosetta, sottorosetta in metallo.  
Handle with rose, metal under-construction.

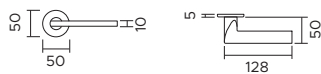

**1239/275R**

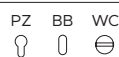

Maniglia con placca.  
Handle with plate.

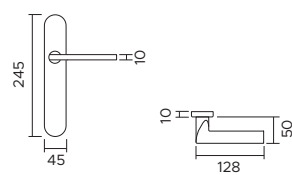

**1239 DK**

Maniglia anta ribalta.  
Tilt and turn handle.

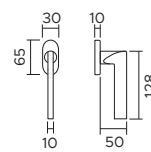

**F05**

Cromo satinato  
satin chrome



**F20**

Nickel satinato  
satin nickel



**F020**

Effetto ottone satinato opaco  
opaque satin brass effect



**FNO**

Nero opaco  
opaque black



**FBO**

Bianco opaco  
opaque white



**F43**

Bronzo graffiato opaco  
opaque satin bronze



più finiture a richiesta / more finishes upon request

# Adele



# Adele 1239

zama / zinc

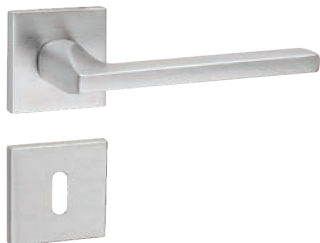

**1239/213**



Maniglia con rosetta, sottorosetta in metallo.  
Handle with rose, metal under-construction.

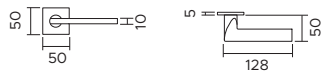

**1239/209**

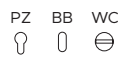

Maniglia con placca.  
Handle with plate.

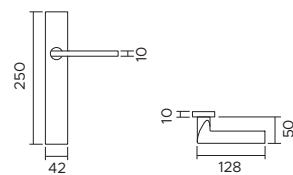

**1239 DKR**

Maniglia anta ribalta.  
Tilt and turn handle.

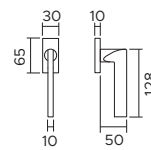

**F05**

Cromo satinato  
satin chrome



**F20**

Nickel satinato  
satin nickel



**F020**

Effetto ottone satinato opaco  
opaque satin brass effect



**FNO**

Nero opaco  
opaque black



**FBO**

Bianco opaco  
opaque white



**F43**

Bronzo graffiato opaco  
opaque satin bronze



più finiture a richiesta / more finishes upon request

# Musa



# Musa 180R

zama / zinc



**180R/208**



Maniglia con rosetta, sottorosetta in metallo.  
*Handle with rose, metal under-construction.*

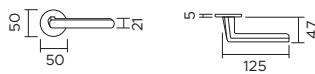

**180R/205**

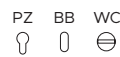

Maniglia con placca.  
*Handle with plate.*

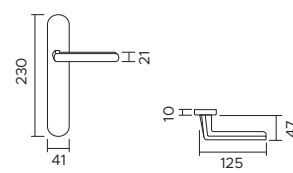

**180R DK**

Maniglia anta ribalta.  
*Tilt and turn handle.*

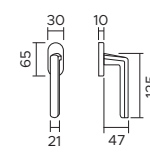

**F04**

Cromo lucido  
*polished chrome*



**F05**

Cromo satinato  
*satın chrome*



**F020**

Effetto ottone satinato opaco  
*opaque satin brass effect*



**FNO**

Nero opaco  
*opaque black*



**F43**

Bronzo graffiato opaco  
*opaque satin bronze*



più finiture a richiesta / more finishes upon request

# Easy

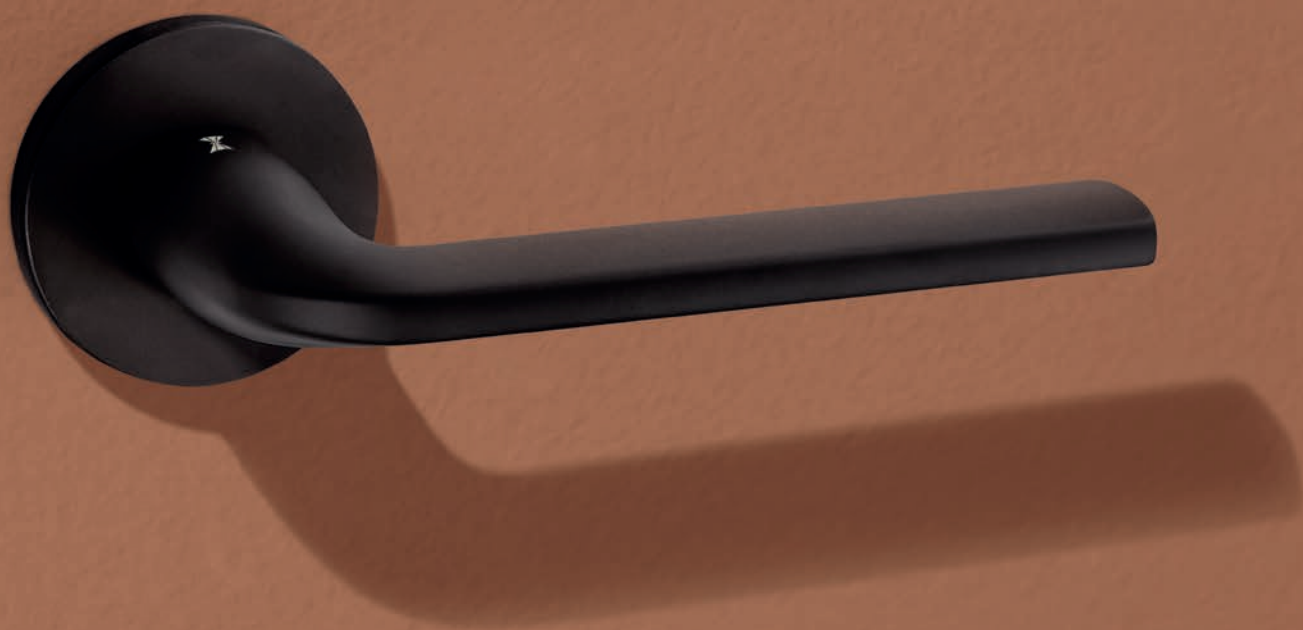

# Easy 1301

zama / zinc



**1301/208**

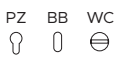

Maniglia con rosetta, sottorosetta in metallo.  
Handle with rose, metal under-construction.

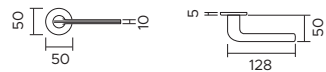

**1301/232**



Maniglia con rosetta clip e sottorosetta in plastica.  
Handle with clip rose and PVC under-construction.

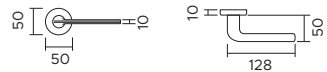

**1301/202L**

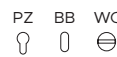

Maniglia con placca.  
Handle with plate.

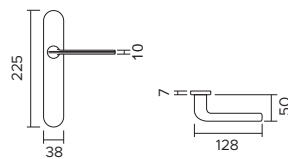

**1301 DK**

Maniglia anta ribalta.  
Tilt and turn handle.

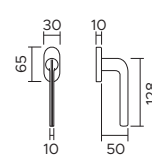

**F04**

cromo lucido  
polished chrome



**F05**

cromo satinato  
satin chrome



**F20**

nickel satinato  
satin nickel



**F020**

effetto ottone satinato opaco  
opaque satin brass effect



**FNO**

nero opaco  
opaque black



**F43**

bronzo graffiato opaco  
opaque satin bronze



più finiture a richiesta / more finishes upon request

# Ice

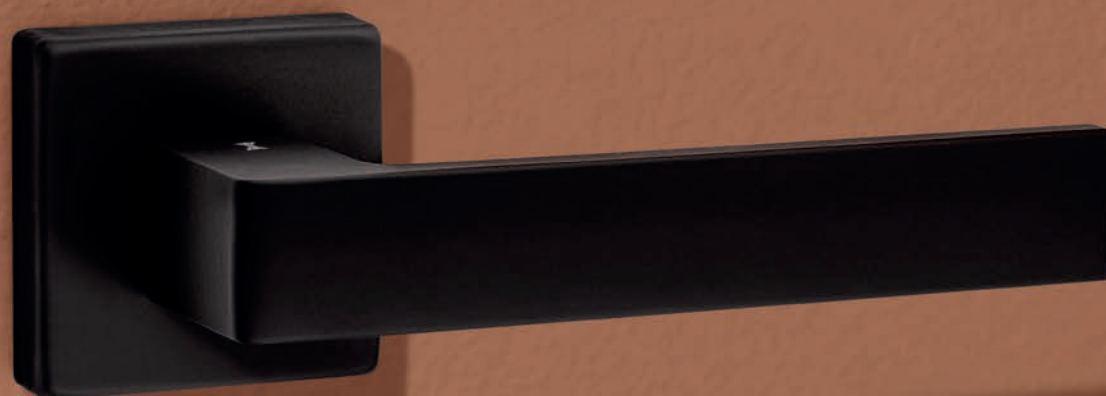

# Ice 168

zama / zinc

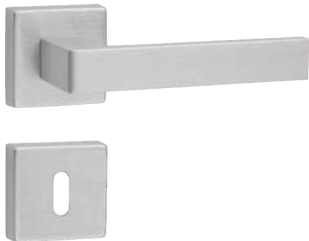

**168/211B**



Maniglia con rosetta clip con sottorosetta in plastica.  
Handle with clip rose and PVC under-construction.

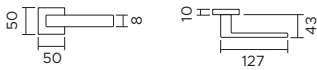

**168/209**

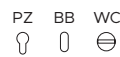

Maniglia con placca.  
Handle with plate.

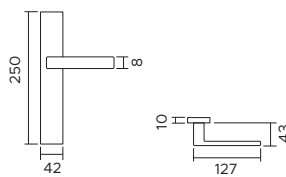

**168 DKR**

Maniglia anta ribalta.  
Tilt and turn handle.

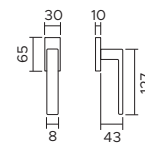

**F04**

chromo lucido  
polished chrome



**F05**

chromo satinato  
satin chrome



**F020**

effetto ottone satinato opaco  
opaque satin brass effect



**F15**

antracite  
anthracite



**FNO**

nero opaco  
opaque black



**FBO**

bianco opaco  
opaque white



più finiture a richiesta / more finishes upon request

# Elle

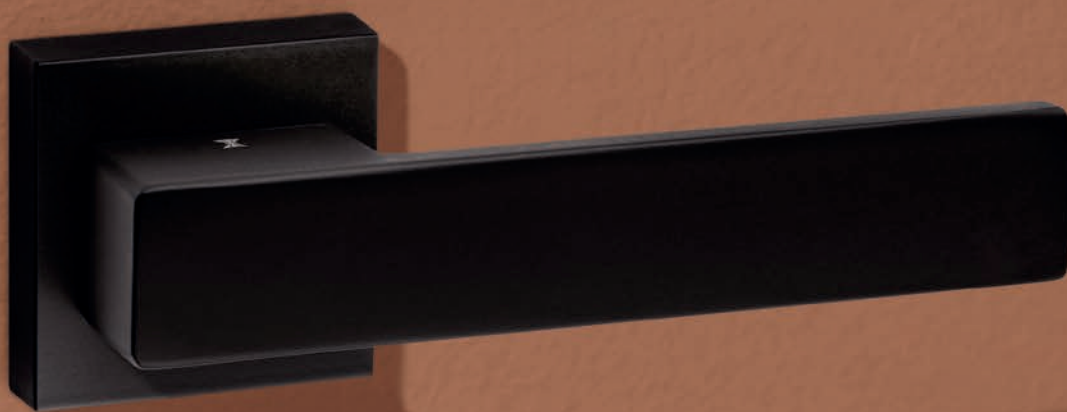

# Elle 132C

zama / zinc

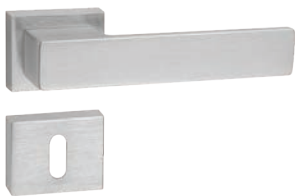

**132C/264**



Maniglia con rosetta clip con sottorosetta in plastica.  
*Handle with clip rose and PVC under-construction.*

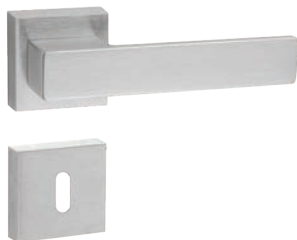
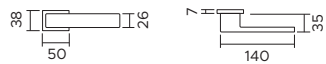

**132C/201**



Maniglia con rosetta clip con sottorosetta in plastica.  
*Handle with clip rose and PVC under-construction.*

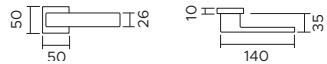

**132C/209**

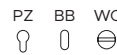

Maniglia con placca.  
*Handle with plate.*

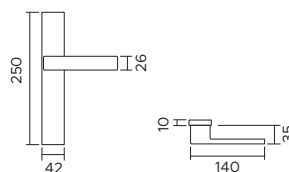

**132C DKR**

Maniglia anta ribalta.  
*Tilt and turn handle.*

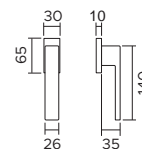

**F05**

Cromo satinato  
*satin chrome*

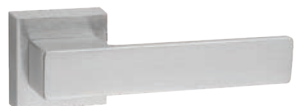

**FNO**

Nero opaco  
*opaque black*



**F54**

Effetto nickel satinato verniciato opaco  
*opaque satin nickel effect*



# Slim



# Slim 1063

zama / zinc



**1063/208**

PZ BB WC

Maniglia con rosetta, sottorosetta in metallo.  
*Handle with rose, metal under-construction.*



**1063/232**

PZ BB WC

Maniglia con rosetta clip con sottorosetta in plastica.  
*Handle with clip rose and PVC under-construction.*

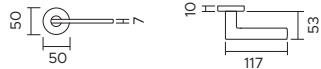

**1063/205**

PZ BB WC

Maniglia con placca.  
*Handle with plate.*

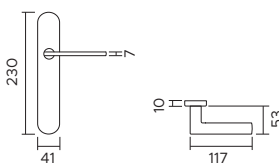

**1063 DK**

Maniglia anta ribalta.  
*Tilt and turn handle.*

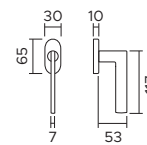

**F04**

cromo lucido  
*polished chrome*



**F05**

cromo satinato  
*satin chrome*



**F20**

nickel satinato  
*satin nickel*



**FNO**

nero opaco  
*opaque black*



**FBO**

bianco opaco  
*opaque white*



più finiture a richiesta / more finishes upon request

# Viper

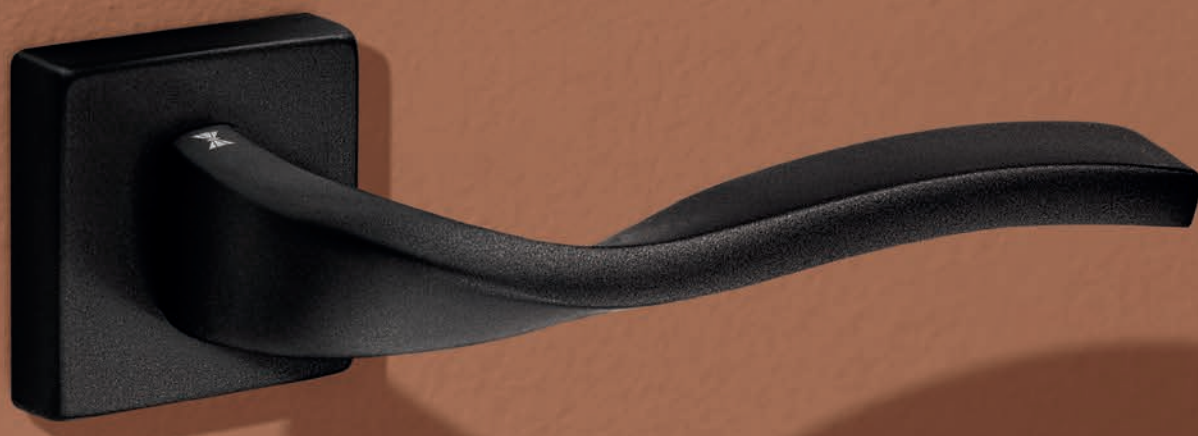

# Viper 1401

zama / zinc

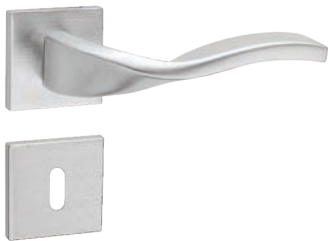

**1401/213**



Maniglia con rosetta, sottorosetta in metallo.  
Handle with rose, metal under-construction.

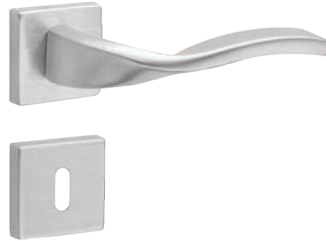
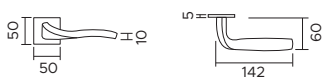

**1401/211B**

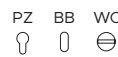

Maniglia con rosetta clip con sottorosetta in plastica.  
Handle with clip rose and PVC under-construction.

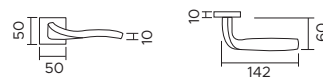

**1401/209**

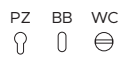

Maniglia con placca.  
Handle with plate.

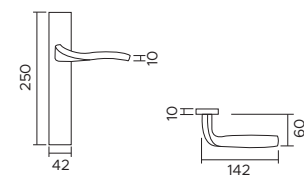

**F05**

Cromo satinato  
satin chrome



**F20**

Nickel satinato  
satin nickel



**FNO**

Nero opaco  
opaque black



**F43**

Bronzo graffiato opaco  
opaque satin bronze



più finiture a richiesta / more finishes upon request

# Wave

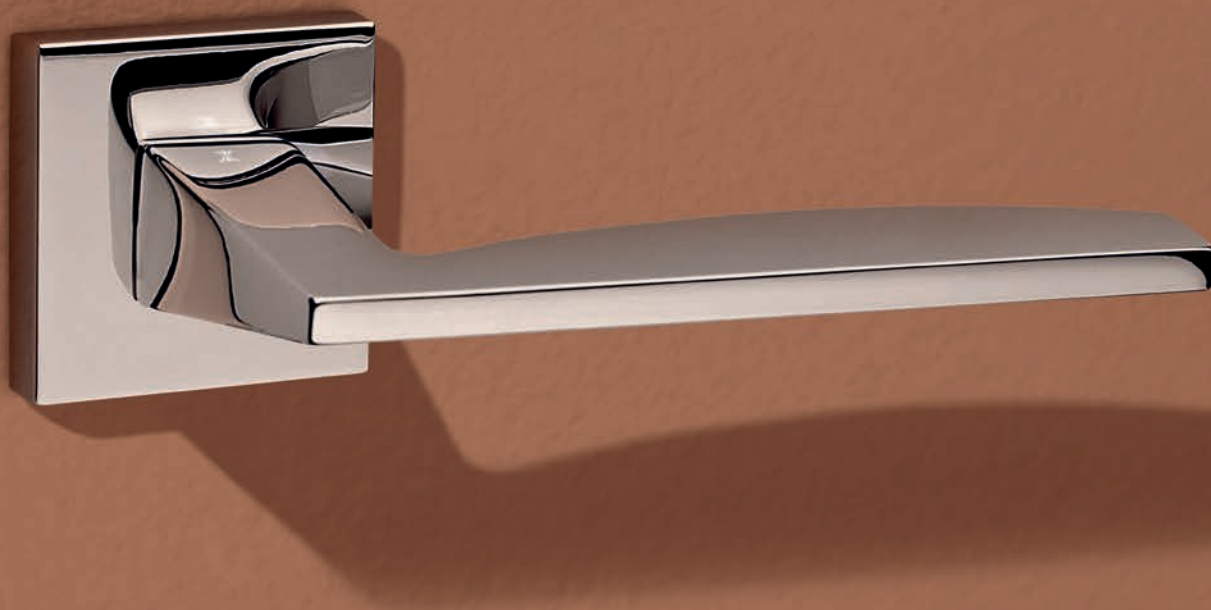

# Wave 190

zama / zinc



**190/201**

PZ BB WC

Maniglia con rosetta clip  
 con sottorosetta in plastica.  
*Handle with clip rose and  
 PVC under-construction.*

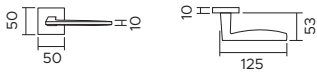

**190/209**

PZ BB WC

Maniglia con placca.  
*Handle with plate.*

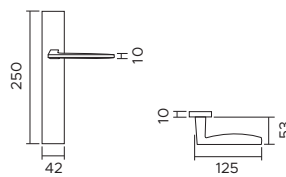

**190 DKR**

Maniglia anta ribalta.  
*Tilt and turn handle.*

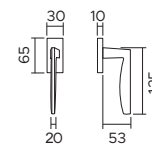

**F04**

cromo lucido  
*polished chrome*



**F05**

cromo satinato  
*satin chrome*



**FNO**

nero opaco  
*opaque black*



# Cut



# Cut 164

zama / zinc

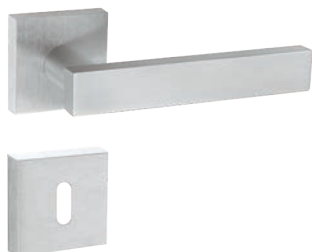

**164/201**

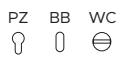

Maniglia con rosetta clip con sottorosetta in plastica.  
Handle with clip rose and PVC under-construction.

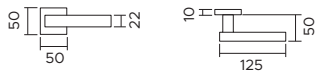

**164/210**

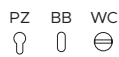

Maniglia con placca.  
Handle with plate.

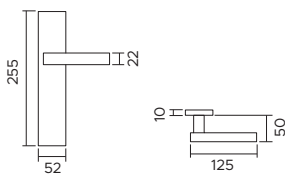

**164 DKR**

Maniglia anta ribalta.  
Tilt and turn handle.

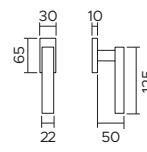

**F05**

chromo satinato  
satin chrome



**F11**

chromo lucido/nickel satinato  
polished chrome/satin nickel



**F43**

bronzo graffiato opaco  
opaque satin bronze



# Kubo

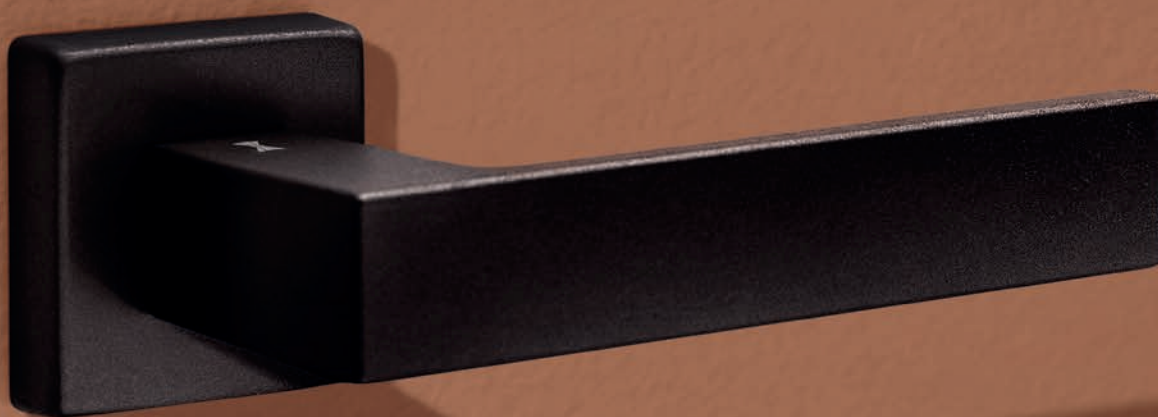

# Kubo 1317

alluminio / aluminum



**1317/211B**



Maniglia con rosetta clip con sottorosetta in plastica.  
*Handle with clip rose and PVC under-construction.*

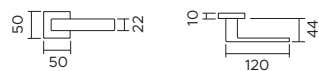

**1317/276**



Maniglia con rosetta rettangolare.  
*Handle with rectangular rose.*

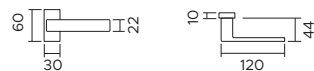

**1317/216**

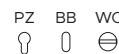

Maniglia con placca.  
*Handle with plate.*

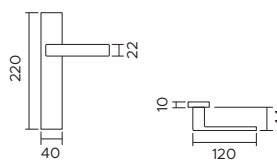

**1317 DKR**

Maniglia anta ribalta.  
*Tilt and turn handle.*

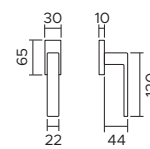

**F16**

effetto cromo satinato  
*satin chrome effect*



**F54**

effetto nickel satinato verniciato opaco  
*opaque satin nickel effect*



**F020**

effetto ottone satinato opaco  
*opaque satin brass effect*



**F15**

antracite  
*anthracite*



**FNO**

nero opaco  
*opaque black*



**FBO**

bianco opaco  
*opaque white*



# Shape



# Shape 1320

alluminio / aluminum



**1320/232**

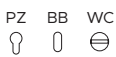

Maniglia con rosetta clip con sottorosetta in plastica.  
Handle with clip rose and PVC under-construction.

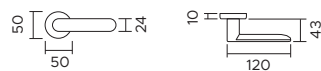

**1320/277**



Maniglia con rosetta ovale.  
Handle with oval rose.

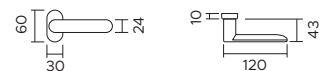

**1320/205**

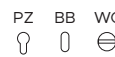

Maniglia con placca.  
Handle with plate.

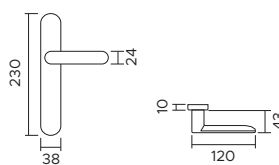

**1320 DK**

Maniglia anta ribalta.  
Tilt and turn handle.

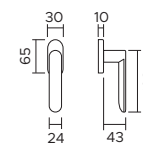

**F16**

effetto cromo satinato  
satin chrome effect



**F54**

effetto nickel satinato verniciato opaco  
opaque satin nickel effect



**F020**

effetto ottone satinato opaco  
opaque satin brass effect



**F15**

antracite  
anthracite



**FNO**

nero opaco  
opaque black



**FBO**

bianco opaco  
opaque white







# Sabrina



# Sabrina 159

zama / zinc



**159/273MA**

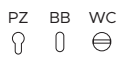

Maniglia con rosetta clip con sottorosetta in plastica.  
Handle with clip rose and PVC under-construction.

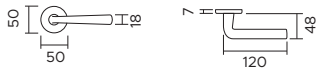

**159/202L**



Maniglia con placca.  
Handle with plate.

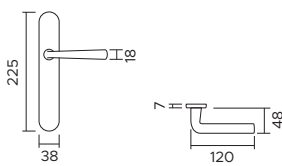

**159 DK**

Maniglia anta ribalta.  
Tilt and turn handle.

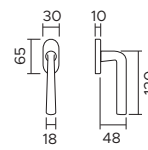

**F04**

cromo lucido  
polished chrome



**F05**

cromo satinato  
satin chrome



**FNO**

nero opaco  
opaque black



# Daniela



# Daniela 179

zama / zinc



**179/273MA**

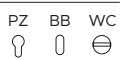

Maniglia con rosetta clip con sottorosetta in plastica.  
Handle with clip rose and PVC under-construction.

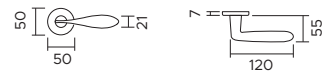

**179/202L**

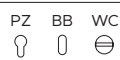

Maniglia con placca.  
Handle with plate.

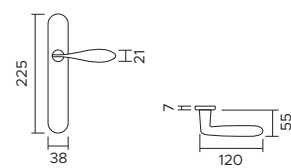

**179 DK**

Maniglia anta ribalta.  
Tilt and turn handle.

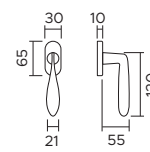

**F04**

cromo lucido  
polished chrome



**F05**

cromo satinato  
satin chrome



**FNO**

nero opaco  
opaque black



# Diamond



# Diamond 199

zama / zinc



**199/273MA**

PZ BB WC

Maniglia con rosetta clip  
 con sottorosetta in plastica.  
*Handle with clip rose and  
 PVC under-construction.*

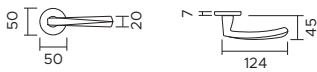

**199/202L**

PZ BB WC

Maniglia con placca.  
*Handle with plate.*

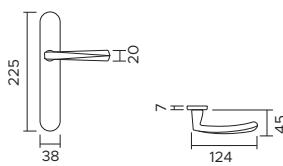

**199 DK**

Maniglia anta ribalta.  
*Tilt and turn handle.*

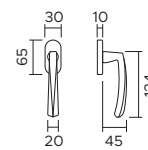

**F04**

cromo lucido  
*polished chrome*



**F05**

cromo satinato  
*satin chrome*



**FNO**

nero opaco  
*opaque black*



# Giorgia



# Giorgia 169

zama / zinc



**169/273MA**



Maniglia con rosetta clip  
con sottorosetta in plastica.  
*Handle with clip rose and  
PVC under-construction.*

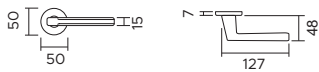

**169/202L**

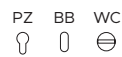

Maniglia con placca.  
*Handle with plate.*

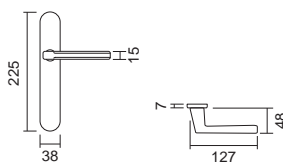

**169 DK**

Maniglia anta ribalta.  
*Tilt and turn handle.*

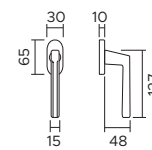

**F05**

Cromo satinato  
*satin chrome*



**FNO**

Nero opaco  
*opaque black*



# Hornet



# Hornet 145

zama / zinc



**145/273MA**

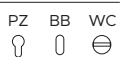

Maniglia con rosetta clip con sottorosetta in plastica.  
Handle with clip rose and PVC under-construction.

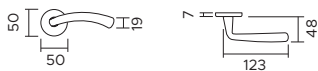

**145/205**

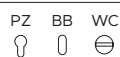

Maniglia con placca.  
Handle with plate.

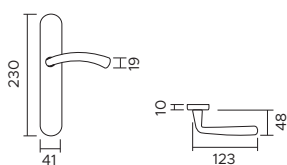

**145 DK**

Maniglia anta ribalta.  
Tilt and turn handle.

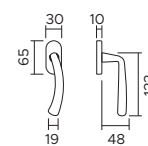

**F05**

Cromo satinato  
satin chrome



**F20**

Nickel satinato  
satin nickel



**FNO**

Nero opaco  
opaque black



# Kate



# Kate 122

zama / zinc



**122/273MA**

PZ BB WC

Maniglia con rosetta clip  
 con sottorosetta in plastica.  
*Handle with clip rose and  
 PVC under-construction.*

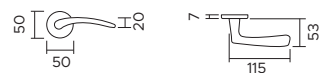

**122/205**

PZ BB WC

Maniglia con placca.  
*Handle with plate.*

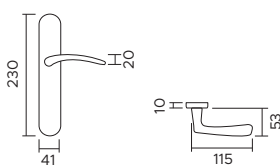

**122 DK**

Maniglia anta ribalta.  
*Tilt and turn handle.*

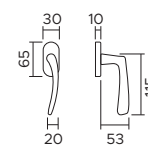

**F05**

Cromo satinato  
*satin chrome*



**FNO**

Nero opaco  
*opaque black*



# Jolie





# Jolie 126

zama / zinc





**126/273MA**

PZ BB WC  
  

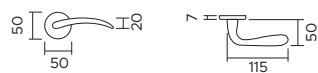
Maniglia con rosetta clip  
 con sottorosetta in plastica.  
*Handle with clip rose and  
 PVC under-construction.*



**126/202L**

PZ BB WC  
  

Maniglia con placca.  
*Handle with plate.*

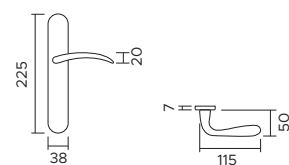

**126 DK**

Maniglia anta ribalta.  
*Tilt and turn handle.*

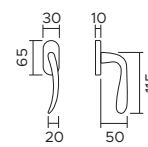

**F04**

cromo lucido  
*polished chrome*



**F05**

cromo satinato  
*satin chrome*



# Grace

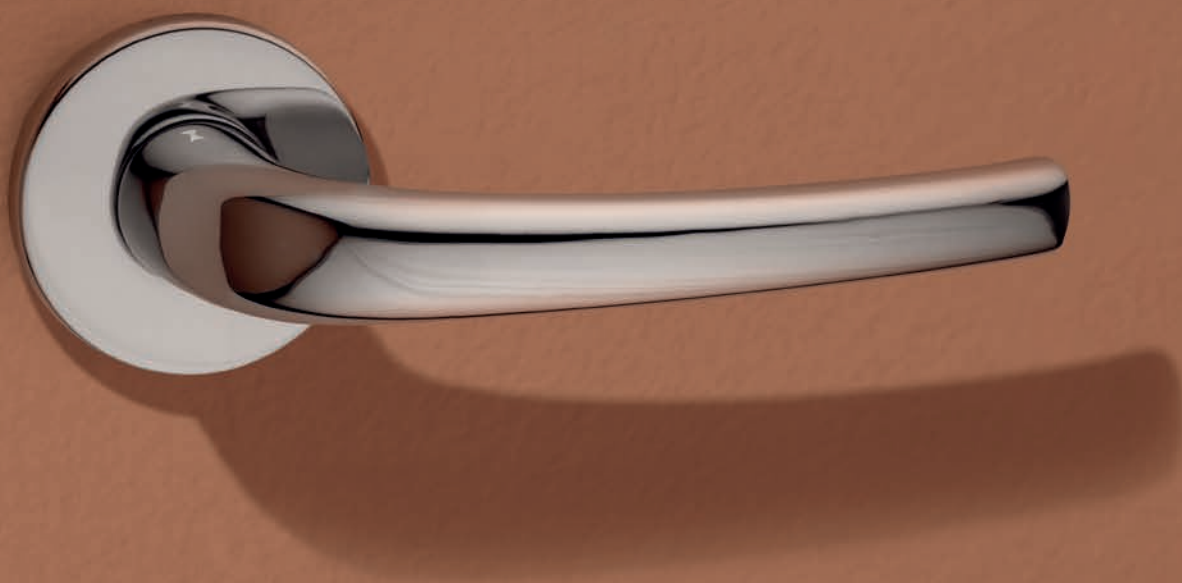

# Grace 127

zama / zinc



**127/273MA**

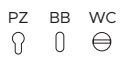

Maniglia con rosetta clip con sottorosetta in plastica.  
Handle with clip rose and PVC under-construction.

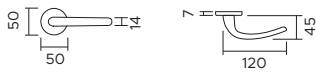

**127/202L**

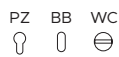

Maniglia con placca.  
Handle with plate.

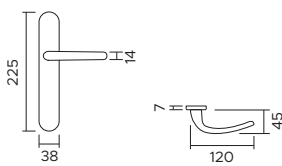

**127 DK**

Maniglia anta ribalta.  
Tilt and turn handle.

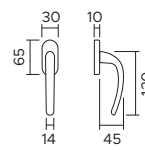

**F04**

Cromo lucido  
polished chrome



**F05**

Cromo satinato  
satin chrome



**F20**

Nickel satinato  
satin nickel



# Fly



# Fly 130

zama / zinc



**130/273MA**



Maniglia con rosetta clip con sottorosetta in plastica.  
Handle with clip rose and PVC under-construction.

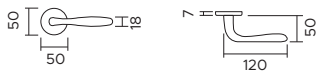

**130/202L**

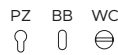

Maniglia con placca.  
Handle with plate.

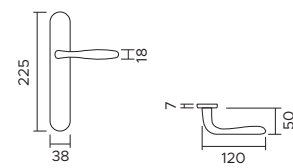

**130 DK**

Maniglia anta ribalta.  
Tilt and turn handle.

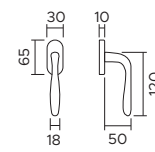

**F01**

ottone lucido  
polished brass



**F04**

cromo lucido  
polished chrome



**F05**

cromo satinato  
satin chrome



**FNO**

nero opaco  
opaque black



più finiture a richiesta / more finishes upon request

# Club

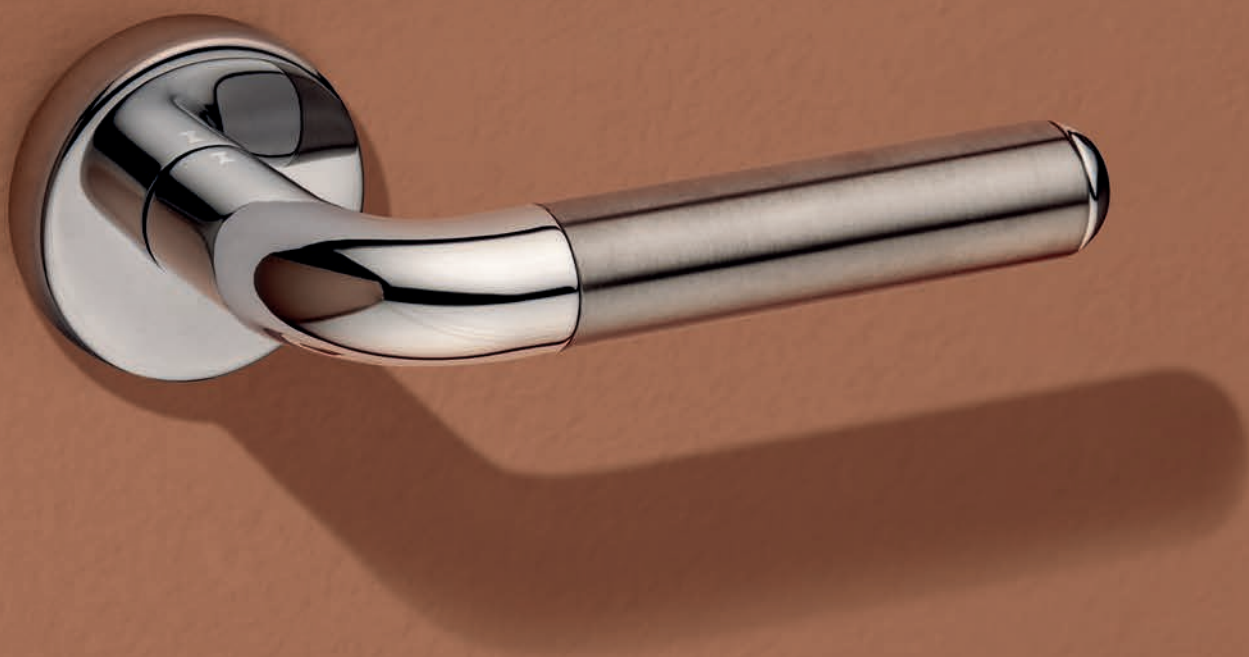

# Club 110

zama / zinc



**110/232**



Maniglia con rosetta clip  
con sottorosetta in plastica.  
*Handle with clip rose and  
PVC under-construction.*

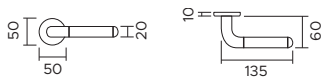

**110/275R**

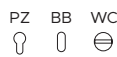

Maniglia con placca.  
*Handle with plate.*

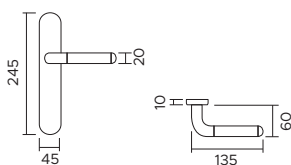

**110 DK**

Maniglia anta ribalta.  
*Tilt and turn handle.*

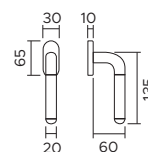

**F65**

cromo lucido/inox satinato  
*polished chrome/satin steel*



**F33**

cromo lucido/nero opaco  
*polished chrome/opaque black*







# Punto

design Robby Cantarutti



# Punto 1205

zama / zinc



## 1205/244 BB

Maniglia con rosetta mini.  
Bocchetta foro chiave.  
*Handle with minimal rose.  
Escutcheon with key hole.*

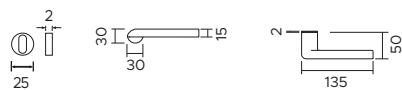
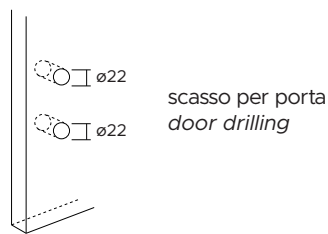

## 1205/244 PZ

Maniglia con rosetta mini.  
Bocchetta foro cilindro.  
*Handle with minimal rose.  
Escutcheon with cylinder hole.*

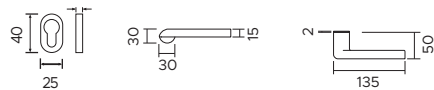
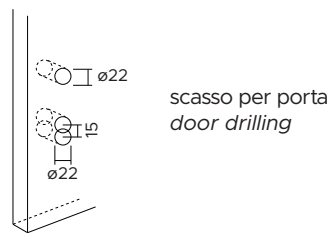

## 1205/244 WC310

Maniglia con rosetta mini.  
Bocchetta foro WC.  
*Handle with minimal rose.  
Escutcheon with WC hole.*

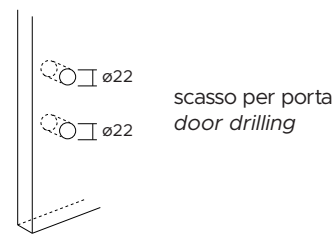

### F04

cromo lucido  
*polished chrome*



### F05

cromo satinato  
*satın chrome*



### FNO

nero opaco  
*opaque black*



### F020

effetto ottone satinato opaco  
*opaque satin brass effect*



più finiture a richiesta / more finishes upon request

# Onda

design Claudio Di Palma

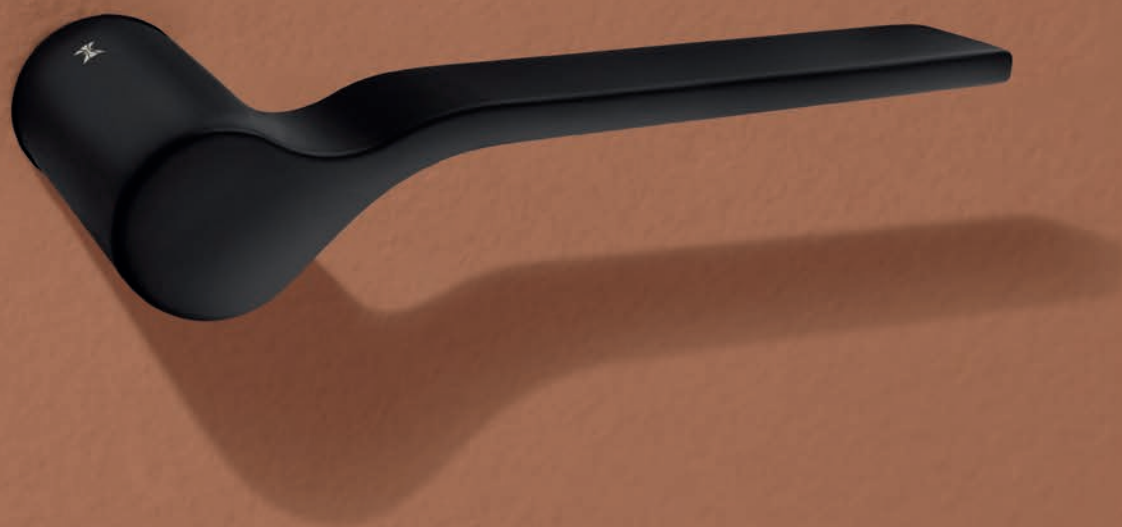

# Onda 1230

zama / zinc



## 1230/241 BB

Maniglia con rosetta mini.  
Bocchetta foro chiave.  
*Handle with minimal rose.  
Escutcheon with key hole.*

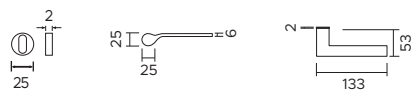
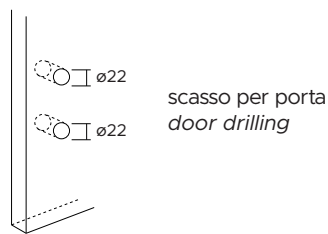

## 1230/241 PZ

Maniglia con rosetta mini.  
Bocchetta foro cilindro.  
*Handle with minimal rose.  
Escutcheon with cylinder hole.*

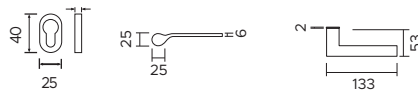
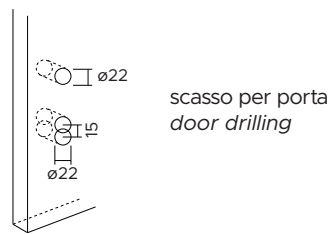

## 1230/241 WC310

Maniglia con rosetta mini.  
Bocchetta foro WC.  
*Handle with minimal rose.  
Escutcheon with WC hole.*

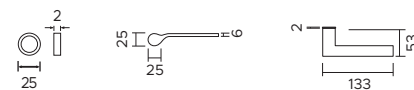
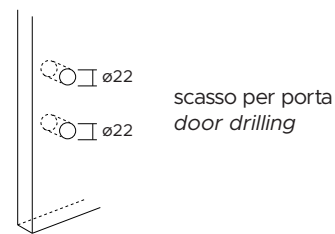

### F04

Cromo lucido  
*polished chrome*



### F05

Cromo satinato  
*satin chrome*



### F020

Effetto ottone satinato opaco  
*opaque satin brass effect*



### FNO

Nero opaco  
*opaque black*



# Pura

design Enrico Gallo



# Pura 1352

zama / zinc



## 1352/243 BB

Maniglia con rosetta mini.  
Bocchetta foro chiave.  
*Handle with minimal rose.  
Escutcheon with key hole.*

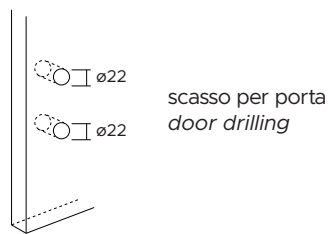

## 1352/243 PZ

Maniglia con rosetta mini.  
Bocchetta foro cilindro.  
*Handle with minimal rose.  
Escutcheon with cylinder hole.*

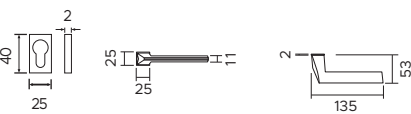
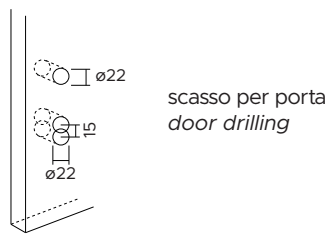

## 1352/243 WC 302

Maniglia con rosetta mini.  
Bocchetta foro WC.  
*Handle with minimal rose.  
Escutcheon with WC hole.*

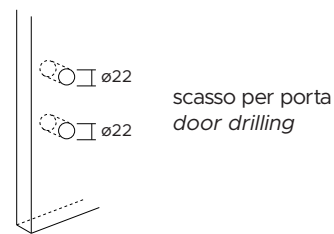

## F04

Cromo lucido  
*polished chrome*



## F05

Cromo satinato  
*satın chrome*



## F54

Effetto nickel sat. verniciato op.  
*opaque satın nickel effect*



## F15

Antracite  
*anthracite*



## FNO

Nero opaco  
*opaque black*



# Kubo



# Kubo 1317

alluminio / aluminum



## 1317/243 BB

Maniglia con rosetta mini.  
Bocchetta foro chiave.  
*Handle with minimal rose.  
Escutcheon with key hole.*

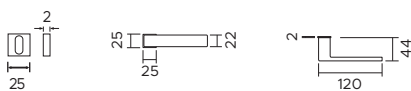
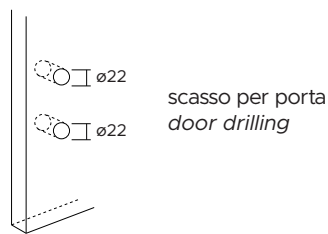

## 1317/243 PZ

Maniglia con rosetta mini.  
Bocchetta foro cilindro.  
*Handle with minimal rose.  
Escutcheon with cylinder hole.*

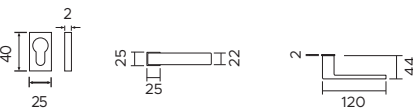
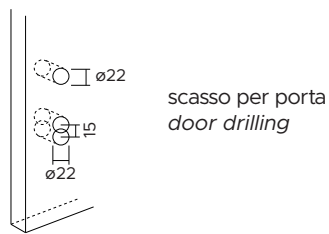

## 1317/243 WC302

Maniglia con rosetta mini.  
Bocchetta foro WC.  
*Handle with minimal rose.  
Escutcheon with WC hole.*

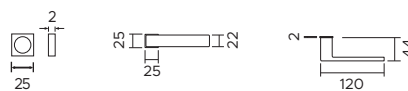
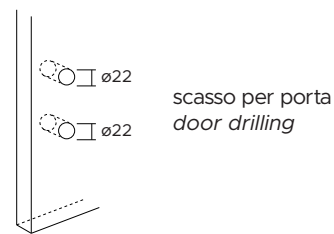

## F16

effetto cromo satinato  
*satin chrome effect*



## F54

effetto nickel satinato verniciato opaco  
*opaque satin nickel effect*



## F020

effetto ottone satinato opaco  
*opaque satin brass effect*



## F15

antracite  
*anthracite*



## FNO

nero opaco  
*opaque black*



## FBO

bianco opaco  
*opaque white*



# Shape



# Shape 1320

alluminio / aluminum



## 1320/241 BB

Maniglia con rosetta mini.  
Bocchetta foro chiave.  
*Handle with minimal rose.  
Escutcheon with key hole.*

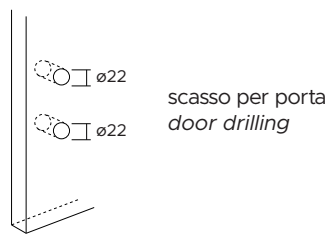

## 1320/241 PZ

Maniglia con rosetta mini.  
Bocchetta foro cilindro.  
*Handle with minimal rose.  
Escutcheon with cylinder hole.*

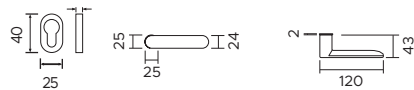
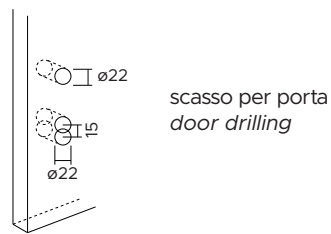

## 1320/241 WC310

Maniglia con rosetta mini.  
Bocchetta foro WC.  
*Handle with minimal rose.  
Escutcheon with WC hole.*

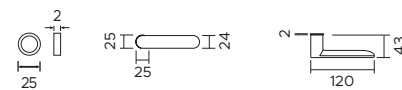
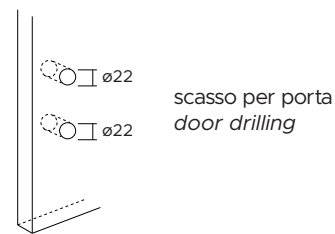

## F16

effetto cromo satinato  
*satin chrome effect*



## F54

effetto nickel satinato verniciato opaco  
*opaque satin nickel effect*



## F020

effetto ottone satinato opaco  
*opaque satin brass effect*



## F15

antracite  
*anthracite*



## FNO

nero opaco  
*opaque black*



## FBO

bianco opaco  
*opaque white*



# Olanda



# Olanda 102

acciaio / stainless steel



## 102/241 BB

Maniglia con rosetta mini.  
Bocchetta foro chiave.  
*Handle with minimal rose.*  
*Escutcheon with key hole.*

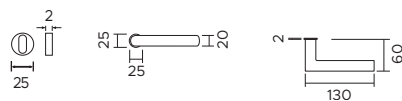
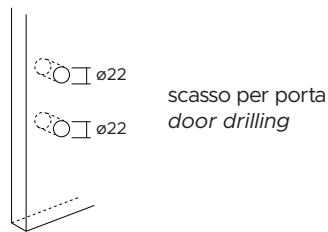

## 102/241 PZ

Maniglia con rosetta mini.  
Bocchetta foro cilindro.  
*Handle with minimal rose.*  
*Escutcheon with cylinder hole.*

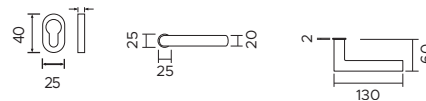
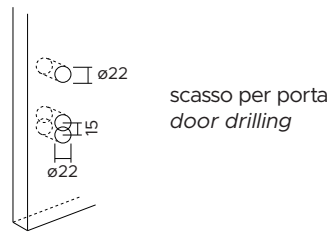

## 102/241 WC310

Maniglia con rosetta mini.  
Bocchetta foro WC.  
*Handle with minimal rose.*  
*Escutcheon with WC hole.*

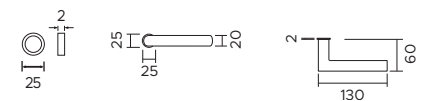
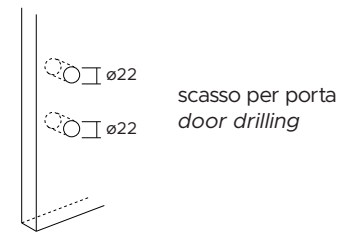

## F61

acciaio lucido  
*polished steel*



## F60

acciaio satinato  
*satin steel*



## F020

effetto ottone satinato opaco  
*opaque satin brass effect*



## FNO

nero opaco  
*opaque black*



## FBO

bianco opaco  
*opaque white*



# Easy

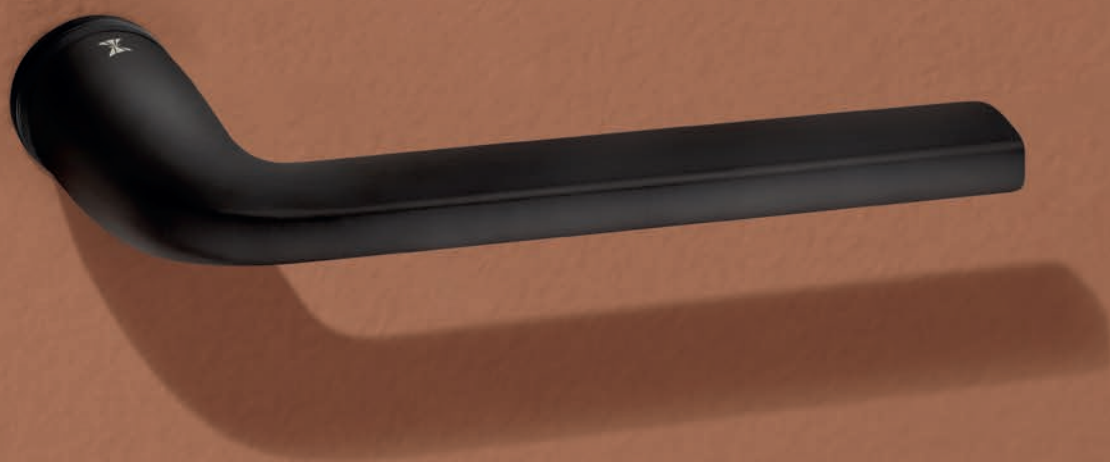

# Easy 1301

zama / zinc



## 1301/241 BB

Maniglia con rosetta mini.  
Bocchetta foro chiave.  
*Handle with minimal rose.  
Escutcheon with key hole.*

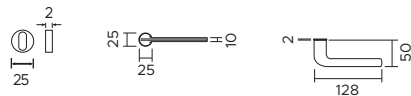
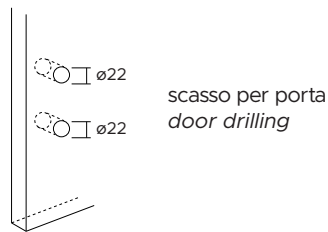

## 1301/241 PZ

Maniglia con rosetta mini.  
Bocchetta foro cilindro.  
*Handle with minimal rose.  
Escutcheon with cylinder hole.*

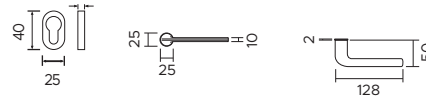
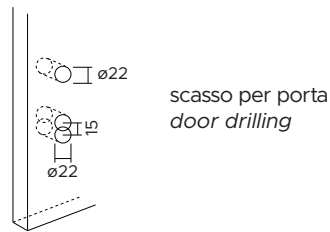

## 1301/241 WC310

Maniglia con rosetta mini.  
Bocchetta foro WC.  
*Handle with minimal rose.  
Escutcheon with WC hole.*

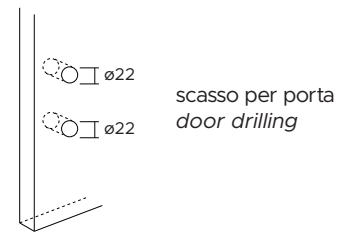

## F04

cromo lucido  
*polished chrome*



## F05

cromo satinato  
*satın chrome*



## FNO

nero opaco  
*opaque black*





# Classico

Classic





# Marion



# Marion 1444

ottone / brass



**1444/208**



Maniglia con rosetta,  
sottorosetta in metallo.  
*Handle with rose,  
metal under-construction.*

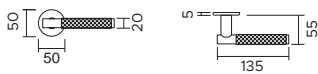

**1444/275R**

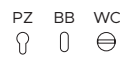

Maniglia con placca.  
*Handle with plate.*

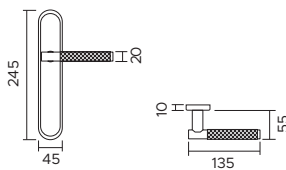

**1444 DK**

Maniglia anta ribalta.  
*Tilt and turn handle.*

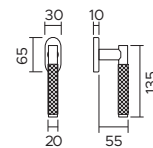

**F01**

ottone lucido  
*polished brass*



**F04**

cromo lucido  
*polished chrome*



**F02**

ottone satinato  
*satın brass*



**F20**

nickel satinato  
*satın nickel*



**FNO**

nero opaco  
*opaque black*



**F43**

bronzo graffiato opaco  
*opaque satın bronze*



più finiture a richiesta / more finishes upon request

# Venezia



# Venezia 1027

ottone / brass



**1027/261**

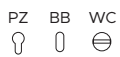

Maniglia con rosetta  
coprivite.  
*Handle with screw-rose.*

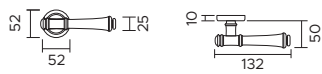

**1027/257**

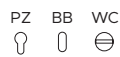

Maniglia con placca.  
*Handle with plate.*

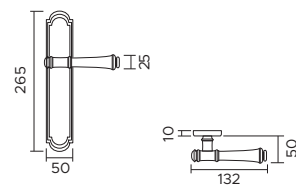

**1027 DK**

Maniglia anta ribalta.  
*Tilt and turn handle.*

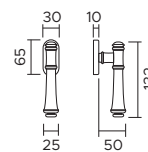

**F01**

ottone lucido  
*polished brass*



**F02**

ottone satinato  
*satin brass*



**F04**

cromo lucido  
*polished chrome*



**FNO**

nero opaco  
*opaque black*



**F43**

bronzo graffiato opaco  
*opaque satin bronze*



più finiture a richiesta / more finishes upon request

# Frau



# Frau 137 O

ottone / brass



**137 O/208**



Maniglia con rosetta,  
sottorosea in metallo.  
*Handle with rose,  
metal under-construction.*



**137 O/275R**

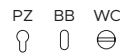

Maniglia con placca.  
*Handle with plate.*

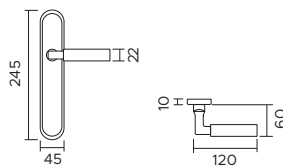

**137 O DK**

Maniglia anta ribalta.  
*Tilt and turn handle.*

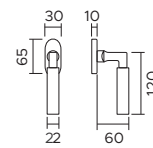

**F01**

ottone lucido  
*polished brass*



**F04**

romo lucido  
*polished chrome*



**F33**

romo lucido/nero opaco  
*polished chrome/opaque black*



**FNO**

nero opaco  
*opaque black*



più finiture a richiesta / more finishes upon request

# Frau

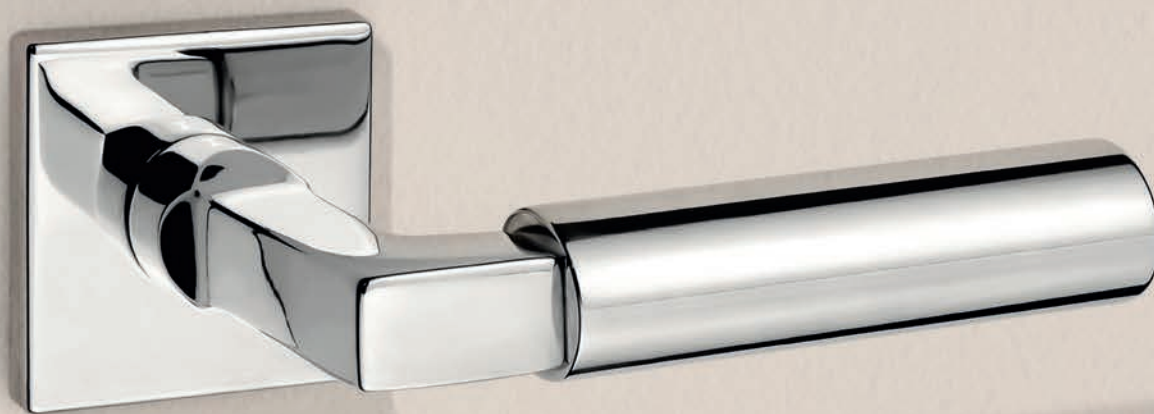

# Frau 137 O

ottone / brass



**137 O/213**



Maniglia con rosetta,  
sottorosetta in metallo.  
*Handle with rose,  
metal under-construction.*



**137 O/210**

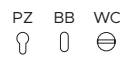

Maniglia con placca.  
*Handle with plate.*

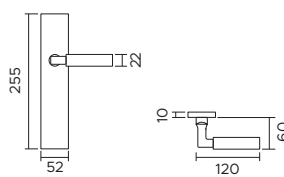

**137 O DKR**

Maniglia anta ribalta.  
*Tilt and turn handle.*

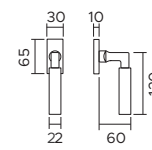

**F01**

ottone lucido  
*polished brass*



**F04**

cromo lucido  
*polished chrome*



**F33**

cromo lucido/nero opaco  
*polished chrome/opaque black*



**FNO**

nero opaco  
*opaque black*



più finiture a richiesta / more finishes upon request

# Nicole

design Fabrizio Gandi



# Nicole 1377

ottone / brass



**1377/261**



Maniglia con rosetta  
coprivite.  
*Handle with screw-rose.*

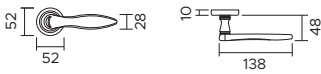

**1377/257**

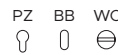

Maniglia con placca.  
*Handle with plate.*

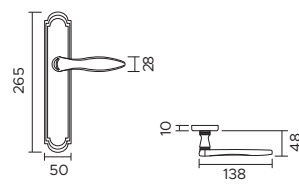

**1377 DK**

Maniglia anta ribalta.  
*Tilt and turn handle.*

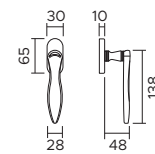

**F01**

ottone lucido  
*polished brass*



**F04**

cromo lucido  
*polished chrome*



**F20**

nickel satinato  
*satin nickel*



**F020**

effetto ottone satinato opaco  
*opaque satin brass effect*



**F43**

bronzo graffiato opaco  
*opaque satin bronze*



più finiture a richiesta / more finishes upon request

# Blossom

design Fabrizio Gandi



# Blossom 1378

ottone / brass



**1378/261**



Maniglia con rosetta coprivite.  
*Handle with screw-rose.*

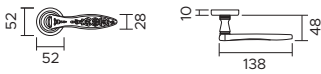

**1378/257**

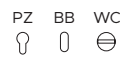

Maniglia con placca.  
*Handle with plate.*

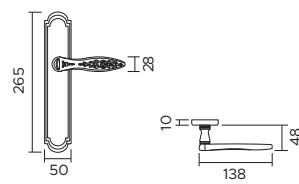

**1378 DK**

Maniglia anta ribalta.  
*Tilt and turn handle.*

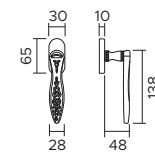

**F01**

ottone lucido  
*polished brass*



**F21**

nickel lucido  
*polished nickel*



**F43**

bronzo graffiato opaco  
*opaque satin bronze*



**F55**

bronzo chiaro/bronzo scuro  
*light bronze/dark bronze*



più finiture a richiesta / more finishes upon request

# Retrò



# Retrò 1380

zama / zinc



**1380/231BT**



Maniglia con rosetta  
coprivite.  
*Handle with screw-rose.*

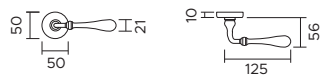

**1380/246**

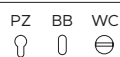

Maniglia con placca.  
*Handle with plate.*

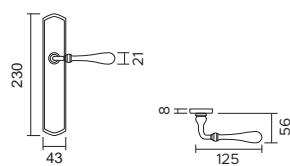

**1380 DK**

Maniglia anta ribalta.  
*Tilt and turn handle.*

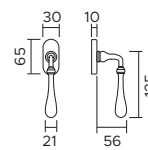

**F01**

ottone lucido  
*polished brass*



**F04**

cromo lucido  
*polished chrome*



**F23**

bronzo antico  
*aged bronzed brass*



**F43**

bronzo graffiato opaco  
*opaque satin bronze*



più finiture a richiesta / more finishes upon request

# Duffy



# Duffy 1379

zama / zinc



**1379/266**

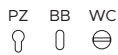

Maniglia con rosetta  
coprivite.  
*Handle with screw-rose.*

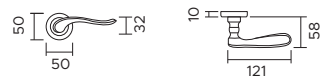

**1379/257**

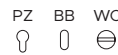

Maniglia con placca.  
*Handle with plate.*

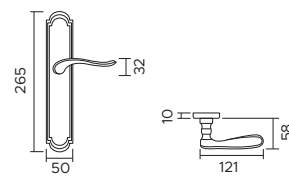

**1379 DK**

Maniglia anta ribalta.  
*Tilt and turn handle.*

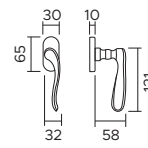

**F01**

ottone lucido  
*polished brass*



**F04**

Cromo lucido  
*polished chrome*



**F05**

Cromo satinato  
*satin chrome*



**F43**

bronzo graffiato opaco  
*opaque satin bronze*



più finiture a richiesta / more finishes upon request

# Tasha



# Tasha 1028

zama ottone / zinc brass



**1028/261**



Maniglia con rosetta  
coprivite.  
*Handle with screw-rose.*

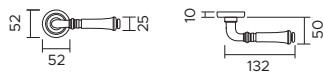

**1028/288**

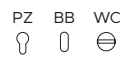

Maniglia con placca.  
*Handle with plate.*

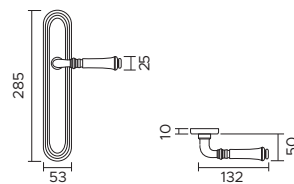

**1028 DK**

Maniglia anta ribalta.  
*Tilt and turn handle.*

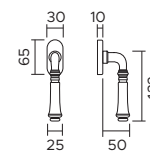

**F01**

ottone lucido  
*polished brass*



**F04**

cromo lucido  
*polished chrome*



**F20**

nickel satinato  
*satin nickel*



**F020**

effetto ottone satinato opaco  
*opaque satin brass effect*



**FNO**

nero opaco  
*opaque black*



**F43**

bronzo graffiato opaco  
*opaque satin bronze*



più finiture a richiesta / more finishes upon request

# Michelle

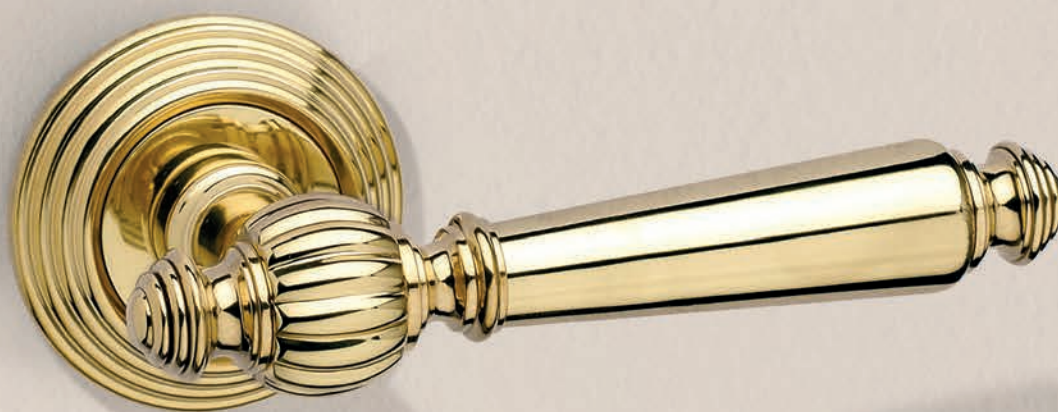

# Michelle 106

ottone / brass



**106/269**



Maniglia con rosetta  
coprivite.  
*Handle with screw-rose.*

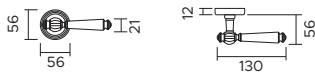

**106/288**

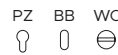

Maniglia con placca.  
*Handle with plate.*

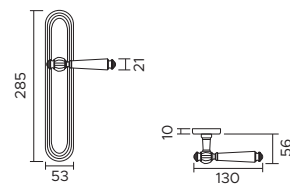

**106 DK**

Maniglia anta ribalta.  
*Tilt and turn handle.*

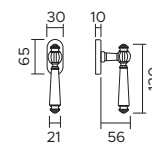

**F01**

ottone lucido  
*polished brass*



**F04**

cromo lucido  
*polished chrome*



**F21**

nickel lucido  
*polished nickel*



**F43**

bronzo graffiato opaco  
*opaque satin bronze*



**F45**

ferro antico  
*antique iron*



**FNO**

nero opaco  
*opaque black*



più finiture a richiesta / more finishes upon request

# Anna

design Fabrizio Gandi  
registrato / registered



# Anna 177

ottone / brass



**177/250F**

PZ BB WC

Maniglia con rosetta  
 coprivite.  
*Handle with screw-rose.*

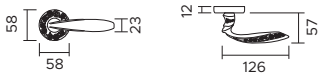

**177/280**

PZ BB WC

Maniglia con placca.  
*Handle with plate.*

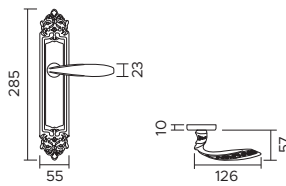

**177 DK**

Maniglia anta ribalta.  
*Tilt and turn handle.*

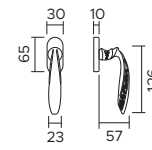

**F01**

ottone lucido  
*polished brass*



**F04**

cromo lucido  
*polished chrome*



**F43**

bronzo graffiato opaco  
*opaque satin bronze*



**F45**

ferro antico  
*antique iron*



più finiture a richiesta / more finishes upon request

# Anna Essence

design Fabrizio Gandi  
registrato / registered



# Anna Essence 177.2

ottone / brass



**177.2/258**



Maniglia con rosetta coprivite.  
Handle with screw-rose.

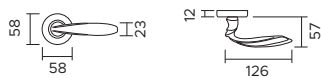

**177.2/275R**

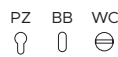

Maniglia con placca.  
Handle with plate.

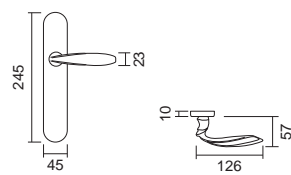

**177.2 DK**

Maniglia anta ribalta.  
Tilt and turn handle.

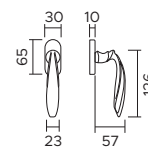

**F01**

ottone lucido  
polished brass



**F04**

Cromo lucido  
polished chrome



**F21**

nickel lucido  
polished nickel



**F10**

ottone lucido/ottone satinato  
polished brass/satin brass



**F43**

bronzo graffiato opaco  
opaque satin bronze



**F45**

ferro antico  
antique iron



più finiture a richiesta / more finishes upon request

# Flora



# Flora 147

ottone / brass



**147/250F**

PZ BB WC

Maniglia con rosetta coprivite.  
*Handle with screw-rose.*

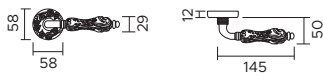

**147/266**

PZ BB WC

Maniglia con rosetta coprivite.  
*Handle with screw-rose.*

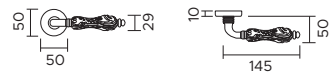

**147/280**

PZ BB WC

Maniglia con placca.  
*Handle with plate.*

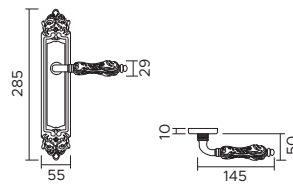

**147 DK**

Maniglia anta ribalta.  
*Tilt and turn handle.*

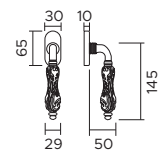

**F01**

ottone lucido  
*polished brass*



**F21**

nickel lucido  
*polished nickel*



**F43**

bronzo graffiato opaco  
*opaque satin bronze*



**F45**

ferro antico  
*antique iron*



più finiture a richiesta / more finishes upon request

# Regina



# Regina 105

ottone / brass



**105/261**

PZ BB WC

Maniglia con rosetta  
 coprivite.  
*Handle with screw-rose.*

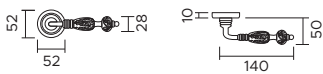

**105/280**

PZ BB WC

Maniglia con placca.  
*Handle with plate.*

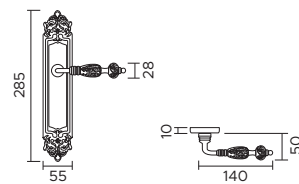

**105 DK**

Maniglia anta ribalta.  
*Tilt and turn handle.*

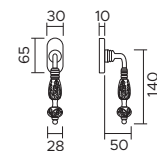

**F21**

nickel lucido  
*polished nickel*



**F02**

ottone satinato  
*satin brass*



**F43**

bronzo graffiato opaco  
*opaque satin bronze*



**F45**

ferro antico  
*antique iron*



più finiture a richiesta / more finishes upon request

# Wien

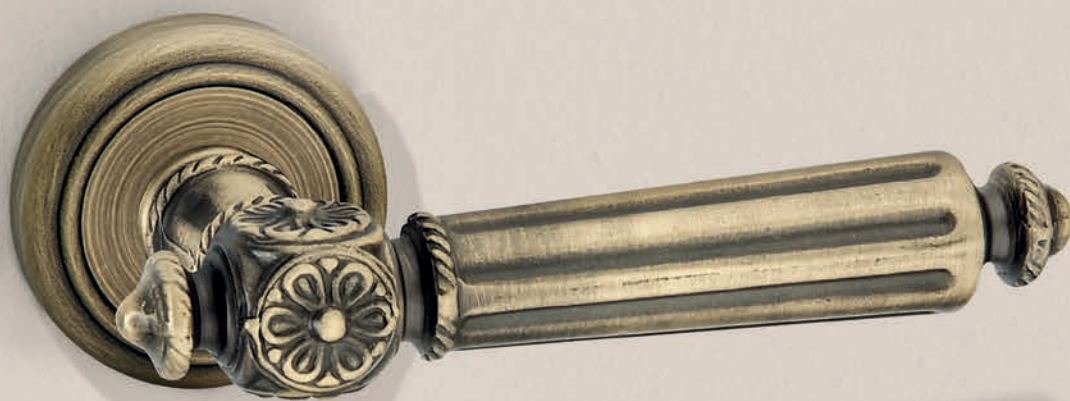

# Wien 109

ottone / brass

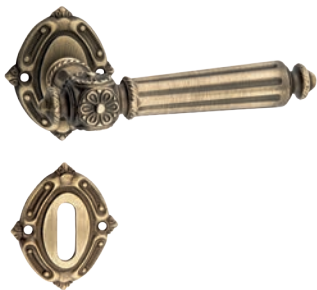

**109/294**



Maniglia con rosetta senza sottorosetta.  
*Handle with rose without under-rose.*

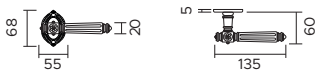

**109/266**

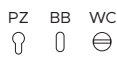

Maniglia con rosetta coprivite.  
*Handle with screw-rose.*

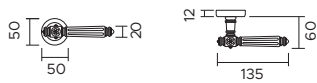

**109/293**

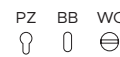

Maniglia con placca.  
*Handle with plate.*

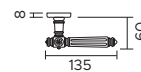
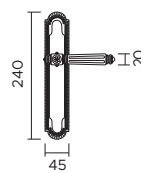

**109 DK**

Maniglia anta ribalta.  
*Tilt and turn handle.*

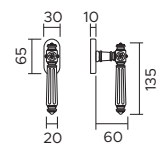

**F01**

ottone lucido  
*polished brass*



**F03**

ottone bronzato  
*shiny bronze*



**F21**

nickel lucido  
*polished nickel*



**F23**

bronzo antico  
*aged bronzed brass*



**F43**

bronzo graffiato opaco  
*opaque satin bronze*



**F45**

ferro antico  
*antique iron*



più finiture a richiesta / more finishes upon request

# Juliette



# Juliette 152

ottone / brass



**152/231C**

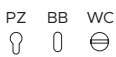

Maniglia con rosetta coprivite.  
Handle with screw-rose.

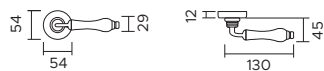

**152/231BT**



Maniglia con rosetta coprivite.  
Handle with screw-rose.

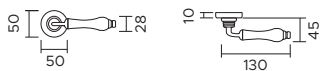

**152/275R**

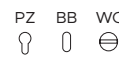

Maniglia con placca.  
Handle with plate.

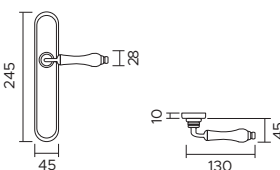

**152 DK**

Maniglia anta ribalta.  
Tilt and turn handle.

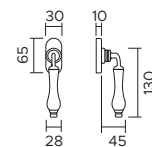

**F01**

ottone lucido  
polished brass



**F21**

nickel lucido  
polished nickel



**F10**

ottone lucido/ottone satinato  
polished brass/satin brass



**F43**

bronzo graffiato opaco  
opaque satin bronze



**F45**

ferro antico  
antique iron



più finiture a richiesta / more finishes upon request

# Paris



# Paris 154

zama / zinc



**154/231BT**



Maniglia con rosetta coprivite.  
*Handle with screw-rose.*

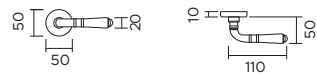

**154/266**

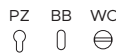

Maniglia con rosetta coprivite.  
*Handle with screw-rose.*

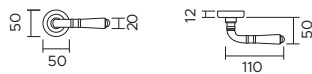

**154/205**

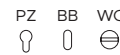

Maniglia con placca.  
*Handle with plate.*

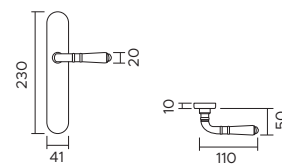

**154 DK**

Maniglia anta ribalta.  
*Tilt and turn handle.*

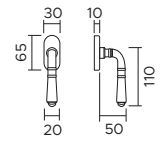

**F01**

ottone lucido  
*polished brass*



**F04**

cromo lucido  
*polished chrome*



**F23**

bronzo antico  
*aged bronzed brass*



**F43**

bronzo graffiato opaco  
*opaque satin bronze*



**F45**

ferro antico  
*antique iron*



**FNO**

nero opaco  
*opaque black*



più finiture a richiesta / more finishes upon request

# Calliope



# Calliope 151

zama / zinc



**151/266**



Maniglia con rosetta coprivite.  
*Handle with screw-rose.*

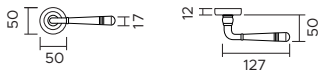

**151/273MA**

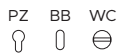

Maniglia con rosetta clip con sottorosetta in plastica.  
*Handle with clip rose and PVC under-construction.*

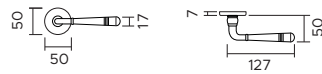

**151/274**

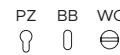

Maniglia con placca.  
*Handle with plate.*

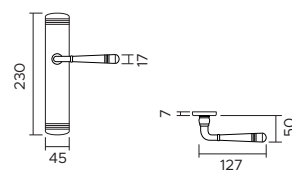

**151 DK**

Maniglia anta ribalta.  
*Tilt and turn handle.*

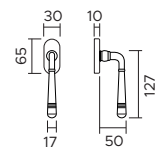

**F01**

ottone lucido  
*polished brass*



**F04**

cromo lucido  
*polished chrome*



**F05**

cromo satinato  
*satin chrome*

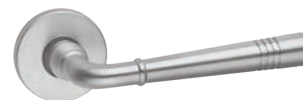

**F20**

nickel satinato  
*satin nickel*



**F23**

bronzo antico  
*aged bronzed brass*



**F43**

bronzo graffiato opaco  
*opaque satin bronze*



**F45**

ferro antico  
*antique iron*



**FNO**

nero opaco  
*opaque black*



più finiture a richiesta / more finishes upon request

# Pisa

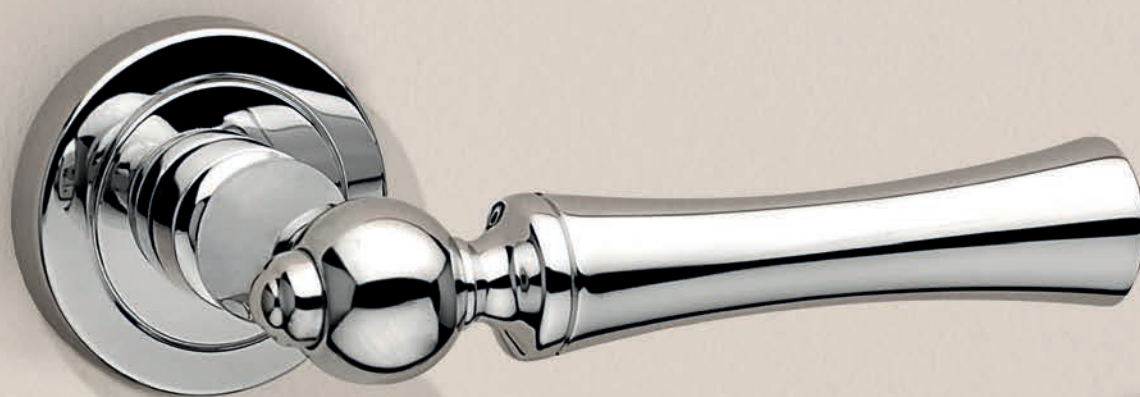

# Pisa 119

ottone / brass



**119/266**

PZ BB WC

Maniglia con rosetta coprivite.  
 Handle with screw-rose.

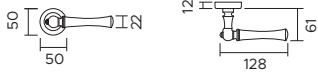

**119/2233**

PZ BB WC

Maniglia con rosetta clip con sottorosea in plastica.  
 Handle with clip rose and PVC under-construction.

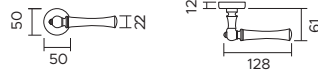

**119/257**

PZ BB WC

Maniglia con placca.  
 Handle with plate.

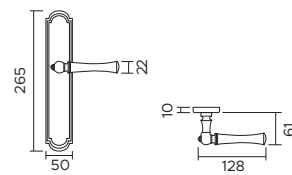

**119 DK**

Maniglia anta ribalta.  
 Tilt and turn handle.

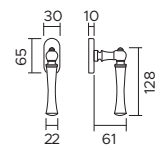

**F01**

ottone lucido  
 polished brass



**F04**

cromo lucido  
 polished chrome



**F21**

nickel lucido  
 polished nickel



# Rodi



# Rodi 138

ottone / brass



**138/266**

PZ BB WC

Maniglia con rosetta coprivite.  
*Handle with screw-rose.*

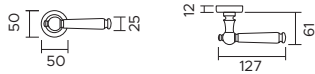

**138/2233**

PZ BB WC

Maniglia con rosetta clip con sottorosea in plastica.  
*Handle with clip rose and PVC under-construction.*

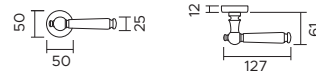

**138/257**

PZ BB WC

Maniglia con placca.  
*Handle with plate.*

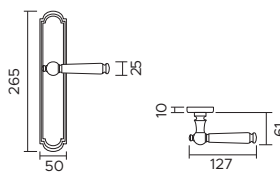

**138 DK**

Maniglia anta ribalta.  
*Tilt and turn handle.*

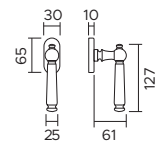

**F01**

ottone lucido  
*polished brass*



**F04**

cromo lucido  
*polished chrome*



**F21**

nickel lucido  
*polished nickel*



**F43**

bronzo graffiato opaco  
*opaque satin bronze*



più finiture a richiesta / more finishes upon request

# Eagle

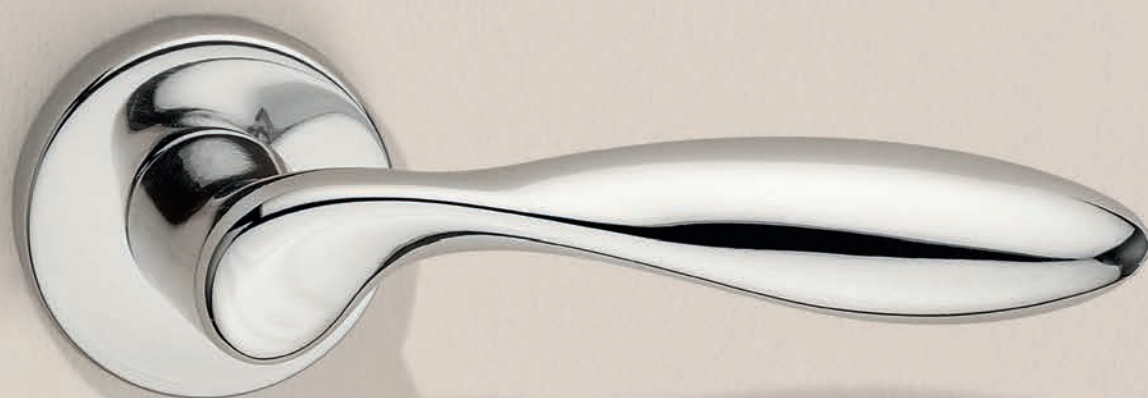

# Eagle 150

zama / zinc



**150/232**



Maniglia con rosetta clip  
con sottorosetta in plastica.  
*Handle with clip rose and  
PVC under-construction.*

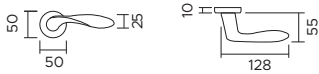

**150/275R**

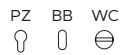

Maniglia con placca.  
*Handle with plate.*

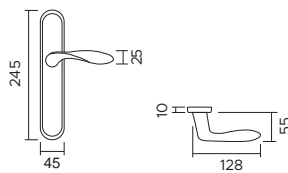

**150 DK**

Maniglia anta ribalta.  
*Tilt and turn handle.*

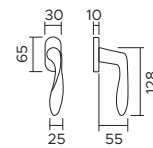

**F04**

cromo lucido  
*polished chrome*



**F05**

cromo satinato  
*satın chrome*



**FNO**

nero opaco  
*opaque black*



# Duck



# Duck 153

ottone / brass



**153/273MA**

PZ BB WC  

Maniglia con rosetta clip  
 con sottorosetta in plastica.  
*Handle with clip rose and  
 PVC under-construction.*

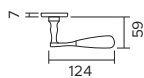
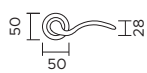

**153/228**

Maniglia con placca.  
*Handle with plate.*

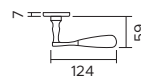
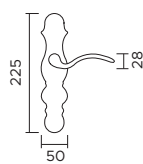

**F01**

ottone lucido  
*polished brass*



**F03**

bronzo graffiato lucido  
*shiny satin bronze*



# Stefania



# Stefania 195

ottone / brass



**195/273MA**

PZ BB WC  
  

Maniglia con rosetta clip con sottorosetta in plastica.

*Handle with clip rose and PVC under-construction.*

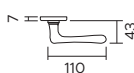
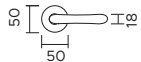

**195/217**

PZ BB WC  
  

Maniglia con placca.

*Handle with plate.*

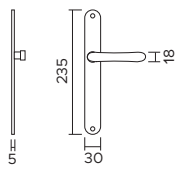

**195/217S**

BB  

Maniglia con placca, con copriforo.

*Handle with plate and hole cover.*

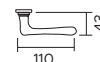
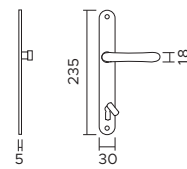

**195C/268**

Cremonese.

*T-handle for window on plate.*

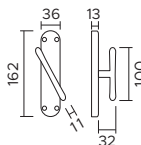

**195 DK**

Maniglia anta ribalta.

*Tilt and turn handle.*

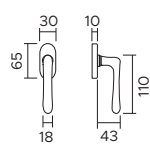

**195 DK.A**

Maniglia anta ribalta su rosetta DKA. *Tilt and turn handle on DKA rose.*

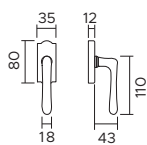

**195C/282**

Martellina su DKA.

*T-handle for window on DKA rose.*

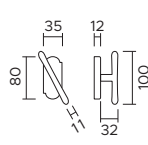

**195C DK**

Martellina su DK.

*T-handle for window on DK rose.*

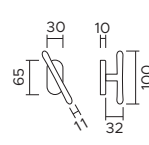

**195C/272**

Martellina su rosetta.

*T-handle for window on rose.*

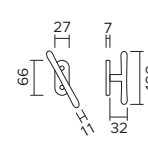

**195M/272**

Segretino.

*Mini handle for window.*

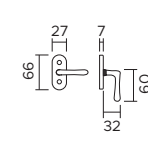

**F01**

ottone lucido  
*polished brass*

**F04**

cromo lucido  
*polished chrome*

**F05**

cromo satinato  
*satin chrome*

più finiture a richiesta / more finishes upon request

# Alt Wien



# Alt Wien 196

ottone / brass



**196/273MA**

PZ BB WC

Maniglia con rosetta clip con sottorosetta in plastica.  
*Handle with clip rose and PVC under-construction.*

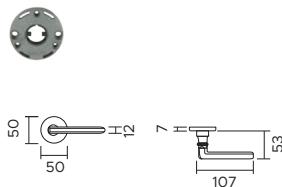

**196/250A**

PZ BB WC

Maniglia con placca.  
*Handle with plate.*

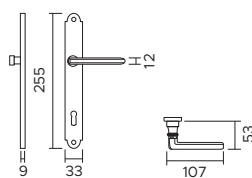

**196/296M/396**

Set maniglia + pomolo con placca di sicurezza.  
*Handle + knob set with safety plate.*

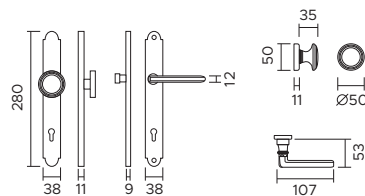

**196/296M/296**

Maniglia con placca di sicurezza.  
*Handle with safety plate.*

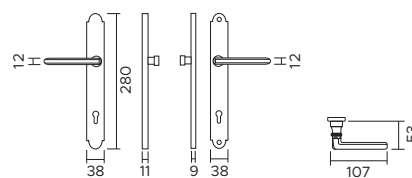

**196C/263**

Cremonese.

*T-handle for window on plate.*

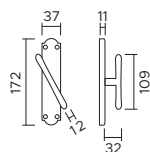

**196 DK**

Maniglia anta ribalta.

*Tilt and turn handle.*

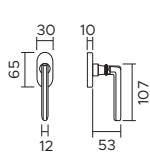

**196 DK.A**

Maniglia anta ribalta su rosetta DKA.  
*Tilt and turn handle on DKA rose.*

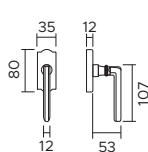

**196C/282**

Martellina su DKA.

*T-handle for window on DKA rose.*

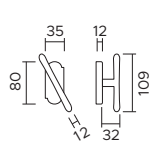

**196C DK**

Martellina su DK.

*T-handle for window on DK rose.*

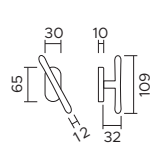

**196C/267**

Martellina su rosetta.

*T-handle for window on rose.*

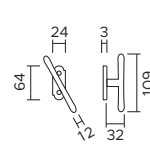

**196M/267**

Segretino.

*Mini handle for window.*

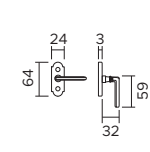

**F01**

ottone lucido  
*polished brass*

**F03**

bronzo graffiato lucido  
*shiny satin bronze*

**F04**

cromo lucido  
*polished chrome*

**F05**

cromo satinato  
*satin chrome*

più finiture a richiesta / more finishes upon request





# Tasha

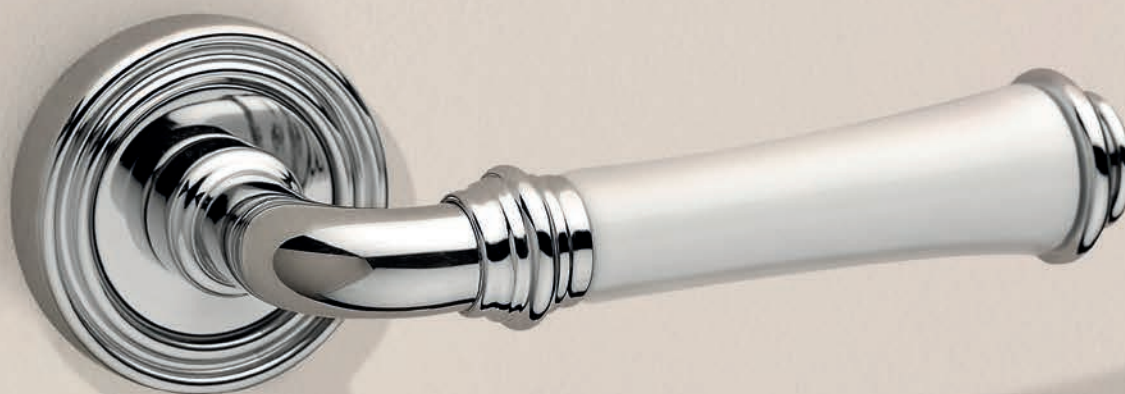

# Tasha 1028P

zama ottone / zinc brass



**1028P/261**

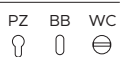

Maniglia con rosetta  
coprivite.  
*Handle with screw-rose.*

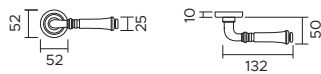

**1028P/288**

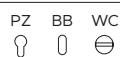

Maniglia con placca.  
*Handle with plate.*

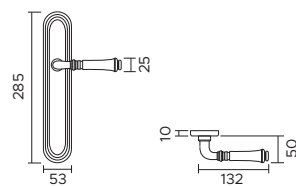

**1028P DK**

Maniglia anta ribalta.  
*Tilt and turn handle.*

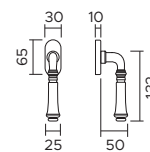

**F04 white**

Cromo lucido  
*polished chrome*



**F43 white**

Bronzo graffiato opaco  
*opaque satin bronze*



**F45 white**

Ferro antico  
*antique iron*



# Anastasia



# Anastasia 198

ottone / brass





**198/266**

PZ BB WC  
  

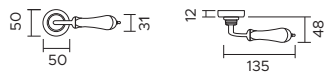
Maniglia con rosetta  
 coprivite.  
*Handle with screw-rose.*



**198/275R**

PZ BB WC  
  

Maniglia con placca.  
*Handle with plate.*

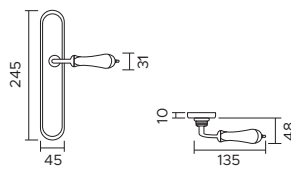

**198 DK**

Maniglia anta ribalta.  
*Tilt and turn handle.*

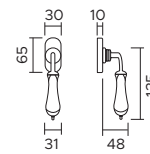

**F01 white/gold**

ottone lucido  
*polished brass*



**F04 white/silver**

cromo lucido  
*polished chrome*



# Lady



# Lady 148

ottone / brass



**148/231C**



Maniglia con rosetta coprivite.  
Handle with screw-rose.

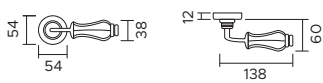

**148/275R**

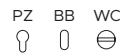

Maniglia con placca.  
Handle with plate.

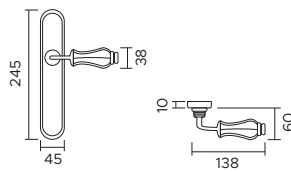

**148 DK**

Maniglia anta ribalta.  
Tilt and turn handle.

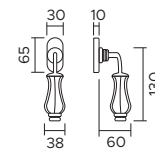

**F01 ivory/gold stripes**

ottone lucido  
polished brass



**F01 white/gold stripes**

ottone lucido  
polished brass



**F23 sand**

bronzo antico  
aged bronzed brass



**F04 white/silver stripes**

romo lucido  
polished chrome



**F21 ivory/silver stripes**

nickel lucido  
polished nickel



**F45 ivory/black stripes**

ferro antico  
antique iron



# Flora



# Flora 147P

ottone / brass



**147P/250F**



Maniglia con rosetta coprivite.  
*Handle with screw-rose.*

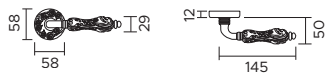

**147P/231C**



Maniglia con rosetta coprivite.  
*Handle with screw-rose.*

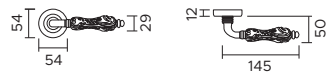

**147P/280**

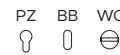

Maniglia con placca.  
*Handle with plate.*

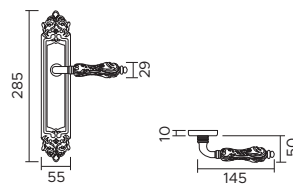

**147P DK**

Maniglia anta ribalta.  
*Tilt and turn handle.*

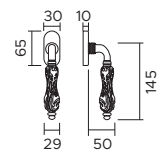

**F01 white/gold**

ottone lucido  
*polished brass*



**F04 white/silver**

cromo lucido  
*polished chrome*



**F04 black/silver**

cromo lucido  
*polished chrome*



# Michelle



# Michelle 106P

ottone / brass



**106P/269**



Maniglia con rosetta  
coprivite.  
*Handle with screw-rose.*

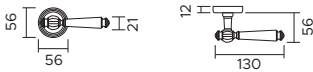

**106P/288**

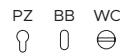

Maniglia con placca.  
*Handle with plate.*

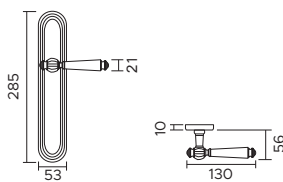

**106P DK**

Maniglia anta ribalta.  
*Tilt and turn handle.*

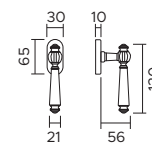

**F04 white**

cromo lucido  
*polished chrome*



**F21 black flower**

nickel lucido  
*polished nickel*



**F45 beige**

ferro antico  
*antique iron*



**F43 white**

bronzo graffiato opaco  
*opaque satin bronze*



**F43 beige**

bronzo graffiato opaco  
*opaque satin bronze*



più finiture a richiesta / more finishes upon request

# Doll

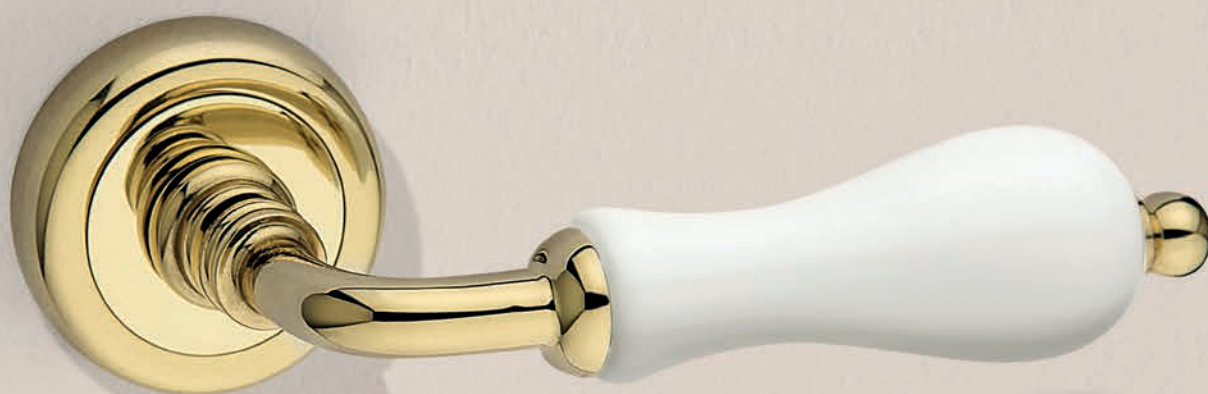

# Doll 141

ottone / brass



**141/231BT**

PZ BB WC  

Maniglia con rosetta coprivite.  
 Handle with screw-rose.

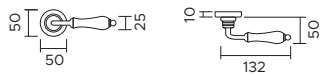

**141/202L**

PZ BB WC  

Maniglia con placca.  
 Handle with plate.

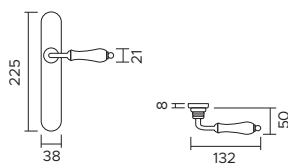

**141 DK**

Maniglia anta ribalta.  
 Tilt and turn handle.

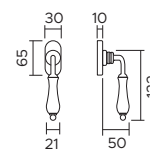

**F01 white**

ottone lucido  
 polished brass



**F03 white**

bronzo graffiato lucido  
 shiny satin bronze



**F03 beige**

bronzo graffiato lucido  
 shiny satin bronze



# Marina

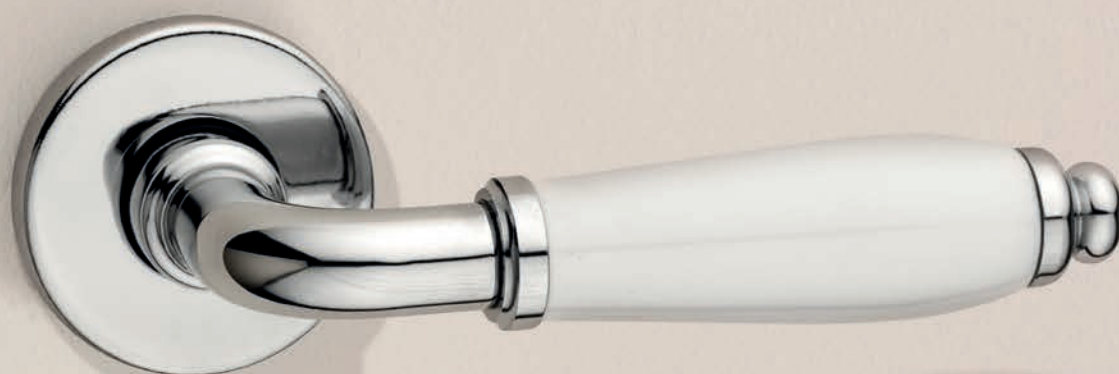

# Marina 108

zama ottone / zinc brass



**108/273MA**



Maniglia con rosetta clip con sottorosetta in plastica.  
Handle with clip roses and PVC under-construction.

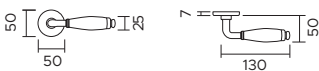

**108/274**

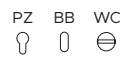

Maniglia con placca.  
Handle with plate.

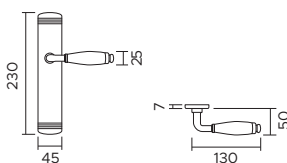

**108 DK**

Maniglia anta ribalta.  
Tilt and turn handle.

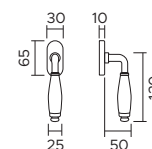

**F01 white**

ottone lucido  
polished brass



**F04 white**

romo lucido  
polished chrome



**F04 black**

romo lucido  
polished chrome



**F43 white**

bronzo graffiato opaco  
opaque satin bronze



**F45 black**

ferro antico  
antique iron



più finiture a richiesta / more finishes upon request

# Stone

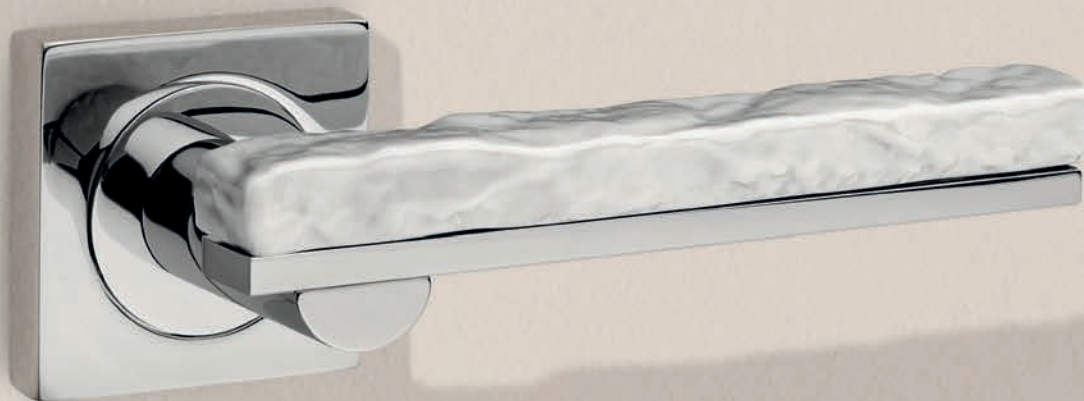

# Stone 161S

ottone / brass



**161S/211BIC**

PZ BB WC

Maniglia con rosetta  
 coprivite.  
*Handle with screw-rose.*

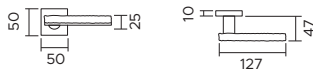

**161S/210**

Maniglia con placca.  
*Handle with plate.*

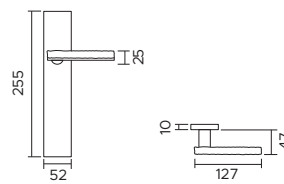

**F04 white**

cromo lucido  
*polished chrome*



**F45 grey**

ferro antico  
*antique iron*



# Square

Porcellana



# Square 160P

zama / zinc



**160P/201**

PZ BB WC

Maniglia con rosetta clip  
 con sottorosetta in plastica.  
*Handle with clip rose and  
 PVC under-construction.*

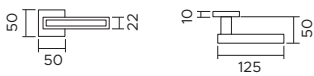

**160P/210**

PZ BB WC

Maniglia con placca.  
*Handle with plate.*

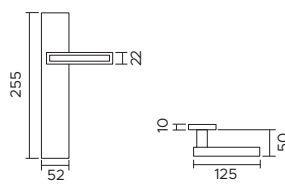

**160P DKR**

Maniglia anta ribalta.  
*Tilt and turn handle.*

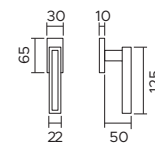

**F04 white**

cromo lucido  
*polished chrome*



**F04 black**

cromo lucido  
*polished chrome*



**F04 zebra**

cromo lucido  
*polished chrome*



# Square

Pelle



# Square 160.3

zama / zinc



**160.3/201**

PZ BB WC

Maniglia con rosetta clip  
 con sottorosetta in plastica.  
*Handle with clip rose and  
 PVC under-construction.*

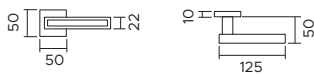

**F04 Nero**

cromo lucido/pelle nera  
*polished chrome/black leather*



**F04 Bianco**

cromo lucido/pelle bianca  
*polished chrome/white leather*



**F04 Cuoio**

cromo lucido/pelle cuoio  
*polished chrome/light brown leather*



**F04 Testa di Moro**

cromo lucido/pelle testa di moro  
*polished chrome/dark brown leather*



Easy line

# Polo 155ALU

alluminio / aluminum



**155ALU/231BS**

PZ BB WC  

Maniglia con rosetta coprivite.  
 Handle with screw-rose.



**F11**

cromo lucido/nickel satinato  
 polished chrome/satin nickel

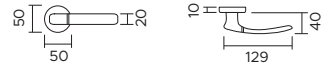

# Stick 116ALU

alluminio / aluminum



**116ALU/231BS**

PZ BB WC  

Maniglia con rosetta coprivite.  
 Handle with screw-rose.



**F11**

cromo lucido/nickel satinato  
 polished chrome/satin nickel

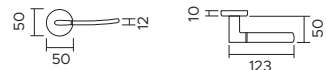

# Venere 186

zama / zinc



**186/231BS**

PZ BB WC  

Maniglia con rosetta coprivite.  
 Handle with screw-rose.



**F66**

cromo lucido/cromo satinato  
 polished chrome/satin chrome

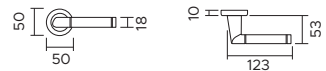

# Mirage 2 125-2

zama / zinc

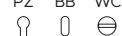

**125-2/231**

PZ BB WC  

Maniglia con rosetta clip  
 con sottorose in plastica.  
 Handle with clip rose and  
 PVC under-construction.



**F65**

cromo lucido/inox satinato  
 polished chrome/satin steel

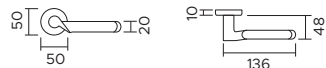

# Quadra 163ALU

alluminio / aluminum



**163ALU/211BIC**

PZ BB WC  
  

Maniglia con rosetta coprivite.  
*Handle with screw-rose.*



**F11**

Cromo lucido/nickel satinato  
*polished chrome/satin nickel*

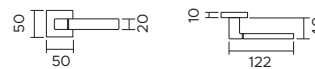

# Fly 130IM

zama / zinc



**130247B05.R.IM**

BB  

Maniglia con rosetta clip con sottorosetta in plastica.  
*Handle with clip rose and PVC under-construction.*



**F05**

Cromo satinato  
*satin chrome*

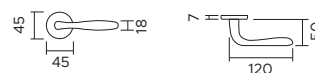

**130247B01.R.IM**

BB  

**F01**

Ottone lucido  
*polished brass*

# Ice 168IM



Maniglia con rosetta 50x50 mm clip con sottorosetta in plastica.  
*Handle with 50x50 mm clip rose and PVC under-construction.*



BB  



**168201B05.ZR.IM**

zama/zinc

BB  

**168201B05.R.IM** alluminio/aluminum

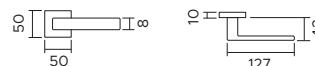
Cromo satinato  
*satin chrome*



Maniglia con rosetta 45x45 mm clip con sottorosetta in plastica.  
*Handle with 45x45 mm clip rose and PVC under-construction.*



BB  



**168215B05.ZR.IM**

zama/zinc

BB  

**168215B05.R.IM** alluminio/aluminum

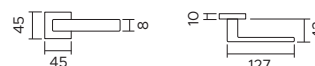
Cromo satinato  
*satin chrome*



321339

zama / zinc



**32133905.FB.IM**

Pomolo con rosetta,  
sottorosetta in metallo.

*Knob with rose,  
metal under-construction.*



**F05**

Cromo satinato  
*satin chrome*

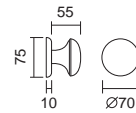

**32133901.FB.IM**

**F01**

Ottone lucido  
*polished brass*



**32133918.FB.IM**

**F18**

PVD giallo lucido  
*polished yellow PVD*

1160.DKRC.0845

alluminio / aluminum



**FBO**

bianco opaco  
*opaque white*



**FNO**

nero opaco  
*opaque black*



**F83**

verniciato argento  
*silver lacquered*



**FGR**

grigio effetto alluminio  
*alu effect grey*

DK con cover a scatto, 8 scatti.

*DK with snap-on cover, 8 positions.*

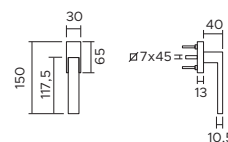

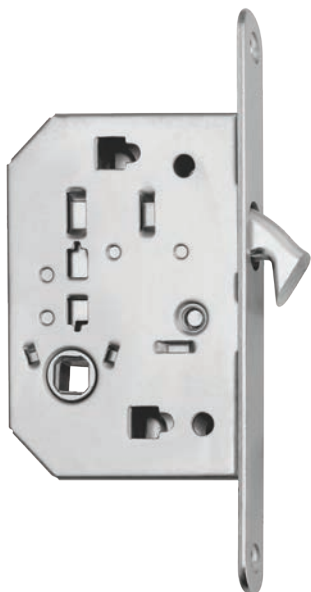

- 3667RMQSEIM.01.IM** ottone lucido / *polished brass*
- 3667RMQSEIM.05.IM** cromo satinato / *satin chrome*
- 3667RMQSEIM.NO.IM** nero opaco / *opaque black*

Paio nicchie foro WC con nottolino ribassato, trascinatore, e serratura WC.

*Pair of WC handles with reduced privacy knob, finger sleeve and lock.*

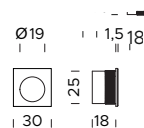

da 38 a 50 mm

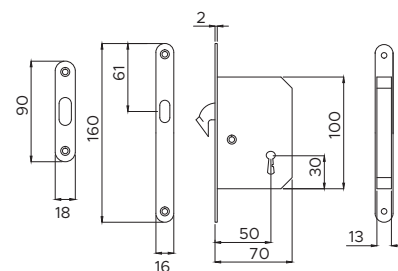
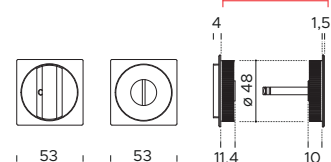

**FRESATURA PER PORTE SCORREVOLI / SLIDING DOORS FLUSH HANDLES MILLING**

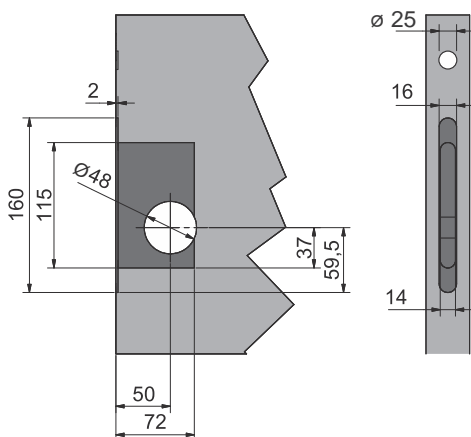

fresatura porta:  $\varnothing 48$  mm  
 tolleranza: + 0,4 mm / - 0,1 mm

*door milling:  $\varnothing 48$  mm  
 tolerance: + 0,4 mm / - 0,1 mm*

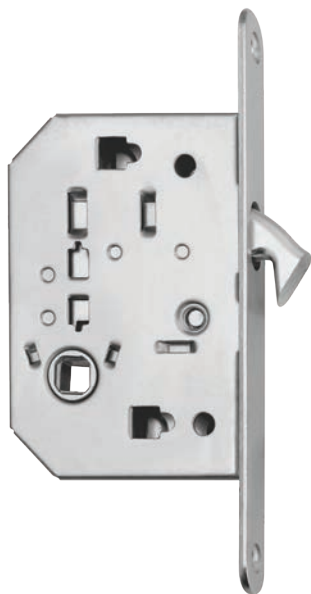

- 3666RMTSEIM.01.IM** ottone lucido / polished brass
- 3666RMTSEIM.05.IM** cromo satinato / satin chrome
- 3666RMTSEIM.NO.IM** nero opaco / opaque black

Paio nicchie foro WC con nottolino ribassato, trascinatore, e serratura WC.

Pair of WC handles with reduced privacy knob, finger sleeve and lock.

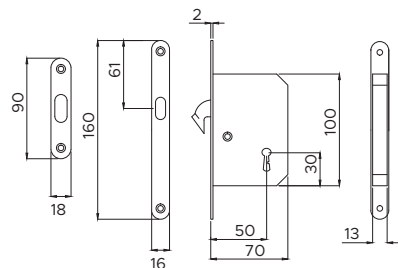
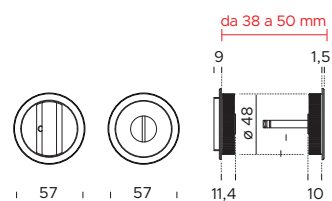
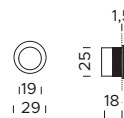

**FRESATURA PER PORTE SCORREVOLI / SLIDING DOORS FLUSH HANDLES MILLING**

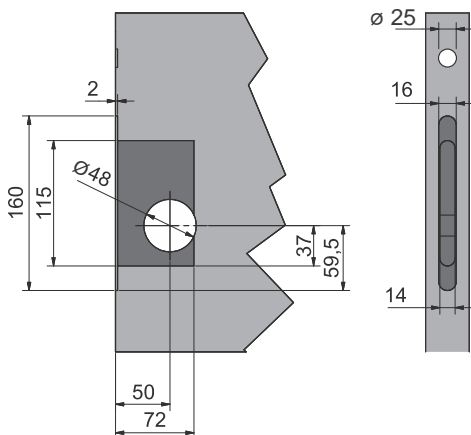

fresatura porta:  $\varnothing 48$  mm  
 tolleranza: + 0,4 mm / - 0,1 mm

door milling:  $\varnothing 48$  mm  
 tolerance: + 0,4 mm / - 0,1 mm



# Accessori

**Accessories**



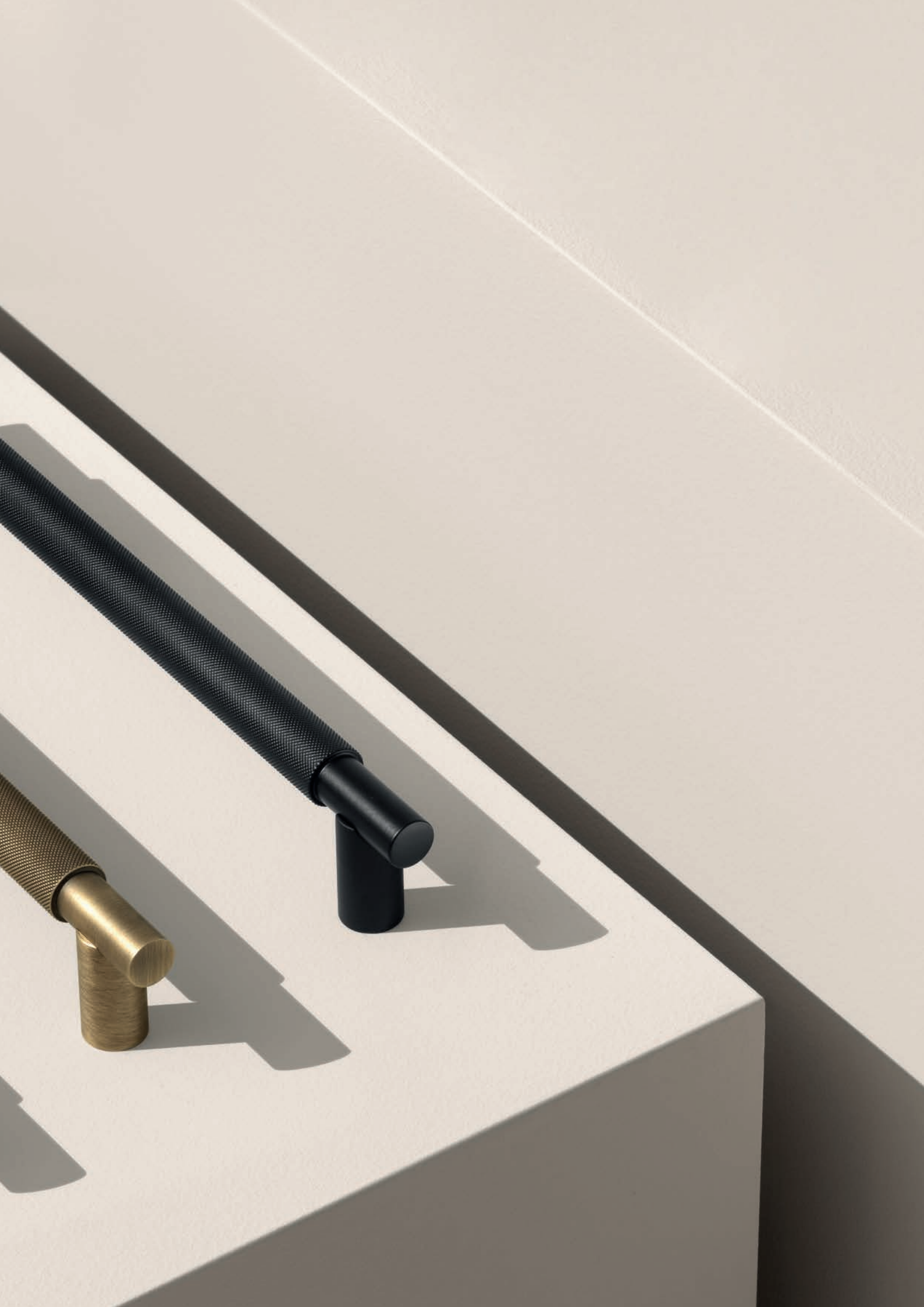

# Futura 1332 STG

zama / zinc



Maniglione  
con supporti diritti.

*Pull-handle with  
straight supports.*

fissaggio / fixing  
FISS01

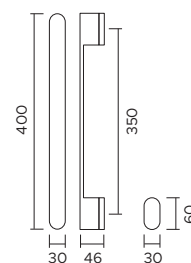

# Cloè 1171 STG

ottone / brass



Maniglione  
con supporti diritti.

*Pull-handle with  
straight supports.*

fissaggio / fixing  
FISS01

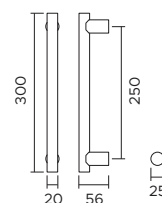

Kubo 1317 STG

alluminio / aluminum



Maniglione  
con supporti dritti.  
*Pull-handle with  
straight supports.*

fissaggio / fixing  
FISS08

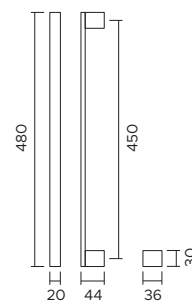
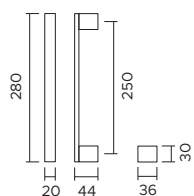

Marion 1444 STG

ottone / brass



Maniglione  
con supporti dritti.  
*Pull-handle with  
straight supports.*

fissaggio / fixing  
FISS01

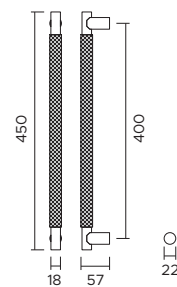
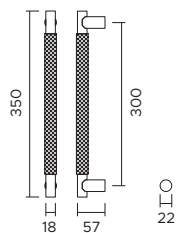

# Rodi 3290

ottone / brass



Maniglione.

*Pull-handle.*

fissaggio / fixing  
FISSUNI - FISS00 - FISS01  
FISS02.OT - FISS14

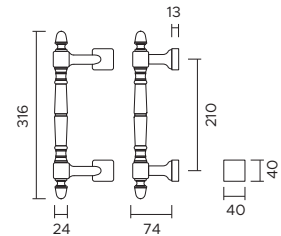
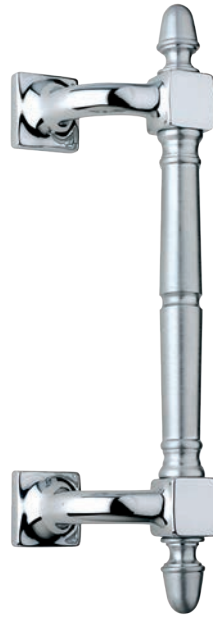
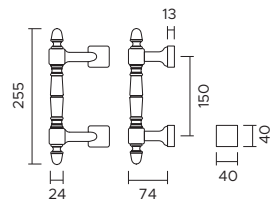

# Atene 3295

ottone | brass

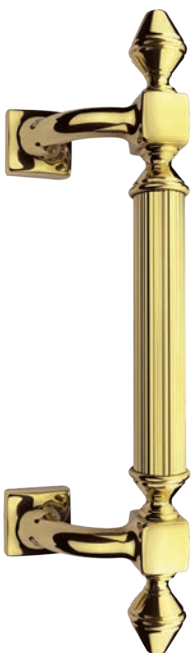

Maniglione.

*Pull-handle.*

fissaggio / fixing  
FISSUNI - FISS00 - FISS01  
FISS02.OT - FISS14

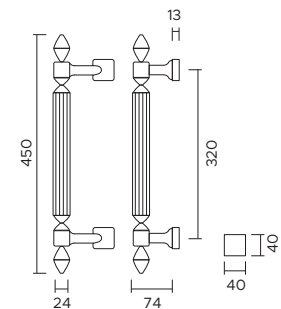
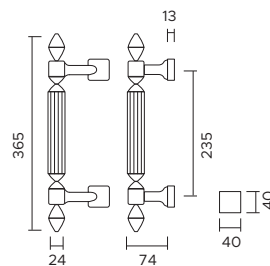

Per progetti, lunghezza su richiesta.

*Different lengths for projects can be produced upon request.*

**Juliette** 152 STG/231C

ottone / brass

**Flora** 147 STG/250F

ottone / brass



Maniglione  
con rosette coprivite.  
*Pull-handle  
with screw-roses.*

fissaggio / fixing  
FISS0061.KIT04

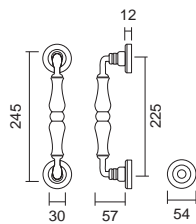

Maniglione  
con rosette coprivite.  
*Pull-handle  
with screw-roses.*

fissaggio / fixing  
FISS0061.KIT04

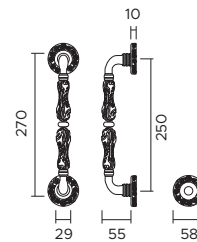

**Paris** 154 STG/266

ottone / brass

**Wien** 3293

ottone / brass



Maniglione  
con rosette coprivite.  
*Pull-handle  
with screw-roses.*

fissaggio / fixing  
FISS0061.KIT04

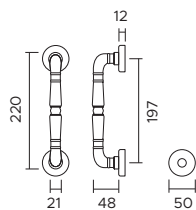

Maniglione.  
*Pull-handle.*

fissaggio / fixing  
FISS01

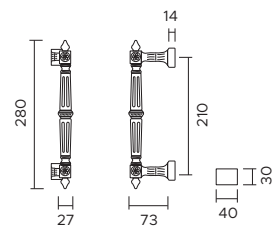

**Tasha** 1028 STG/261

zama ottone / zinc brass

**Regina** 105 STG/261

ottone / brass



Maniglione con rosette coprivite.  
*Pull-handle with screw-roses.*

fissaggio / fixing  
FISS0061.KIT04

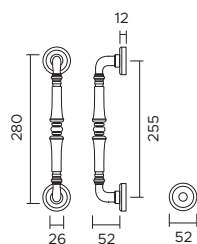

Maniglione con rosette coprivite.  
*Pull-handle with screw-roses.*

fissaggio / fixing  
FISS0061.KIT04

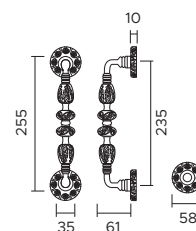

**Pisa** 119 STG/266

ottone / brass

**Urano** 3292

ottone / brass



Maniglione con rosette coprivite.  
*Pull-handle with screw-roses.*

fissaggio / fixing  
FISS0061.KIT04

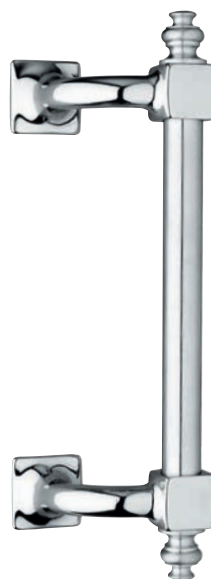
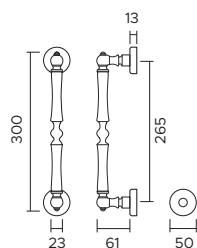

Maniglione.  
*Pull-handle.*

fissaggio / fixing  
FISSUNI - FISS00 - FISS01  
FISS02.OT - FISS14

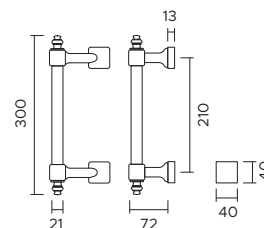

**Michelle** 106 STG/269

ottone / brass

**Marina** 108 STG/273

zama / zinc



Maniglione con rosette coprivite.  
*Pull-handle with screw-roses.*

fissaggio / fixing  
FISS0061.KIT04

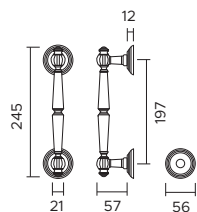

Maniglione con rosetta clip, sottorosetta in plastica.  
*Pull-handle with clip rose and PVC under-construction.*

fissaggio / fixing  
FISS0061.KIT04

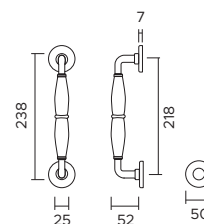

**Michelle** 106P STG/269

ottone / brass

**Doll** 141/231BT STG

ottone / brass



Maniglione con rosette coprivite.  
*Pull-handle with screw-roses.*

fissaggio / fixing  
FISS0061.KIT04

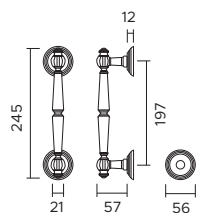

Maniglione con rosette coprivite.  
*Pull-handle with screw-roses.*

fissaggio / fixing  
FISS0061.KIT04

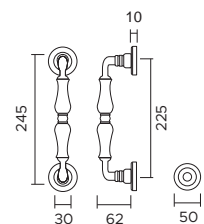

**Tasha** 1028P STG/261

zama ottone / zinc brass

**Flora** 147P STG/250F

ottone / brass



Maniglione con rosette coprivite.  
*Pull-handle with screw-roses.*

fissaggio / fixing  
FISS0061.KIT04

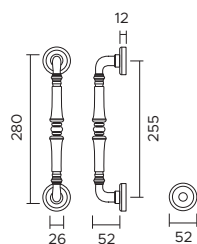

Maniglione con rosette coprivite.  
*Pull-handle with screw-roses.*

fissaggio / fixing  
FISS0061.KIT04

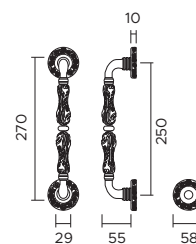

**Lady** 148 STG/231C

ottone / brass

**Anastasia** 198 STG/266

ottone / brass



Maniglione con rosette coprivite.  
*Pull-handle with screw-roses.*

fissaggio / fixing  
FISS0061.KIT04

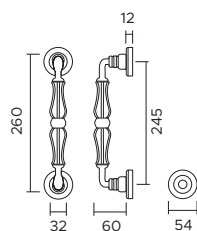

Maniglione con rosette coprivite.  
*Pull-handle with screw-roses.*

fissaggio / fixing  
FISS0061.KIT04

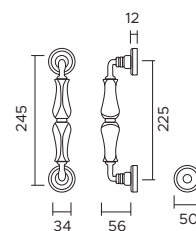

**FISS0061.KIT04**

Kit di fissaggio / Fixing kit

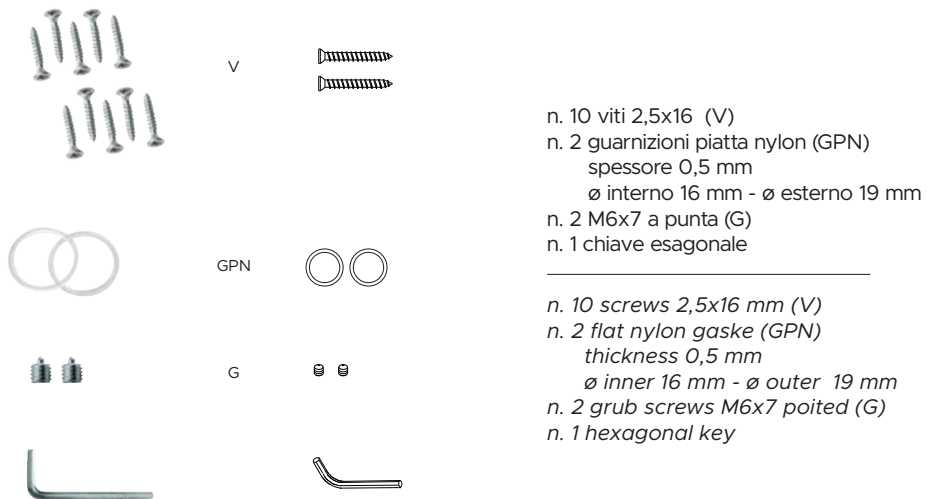
**FISS008**

Kit di fissaggio / Fixing kit

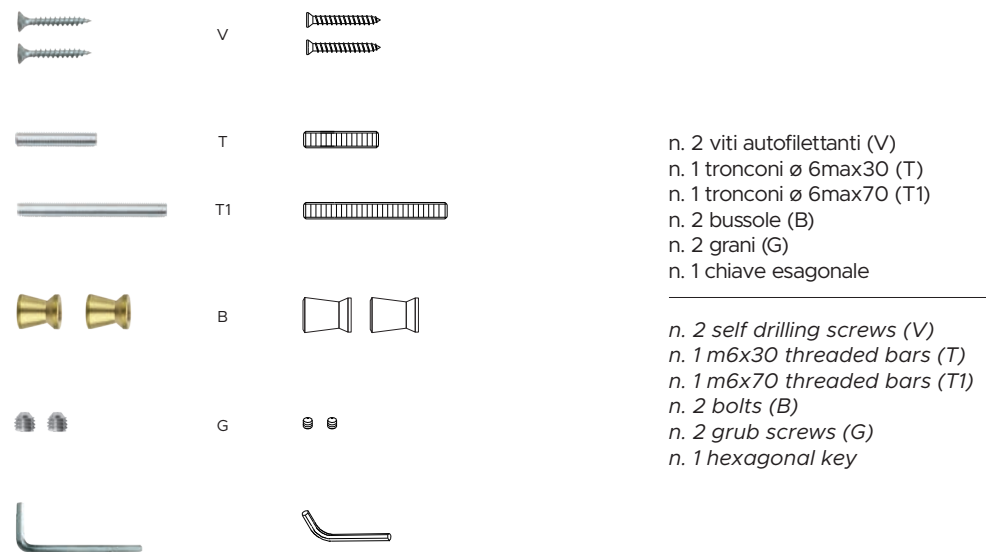

**FISSUNI**

Kit di fissaggio universale / Universal fixing kit

Possibilità di montaggio / Possibility of assembly

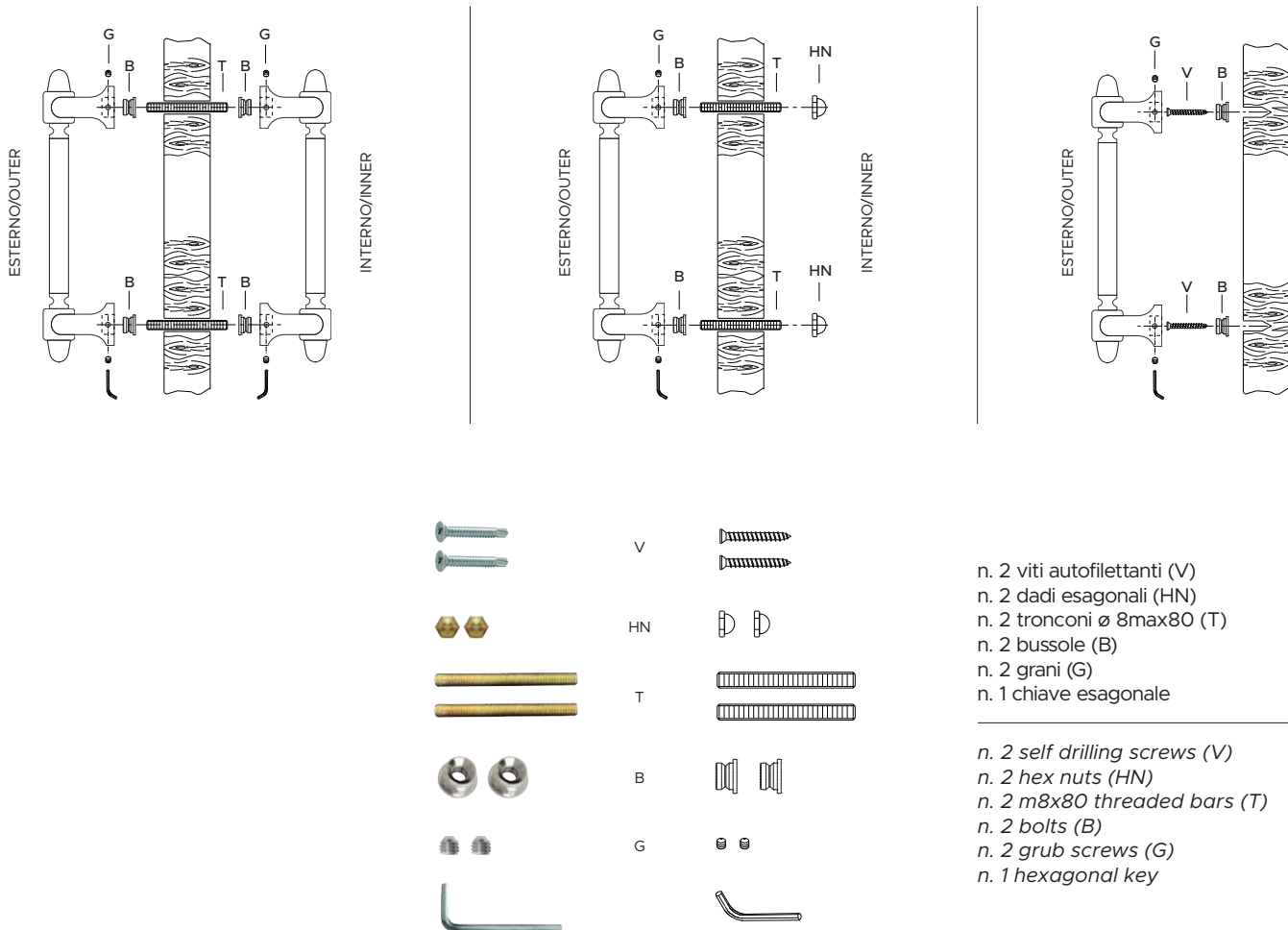

**FISS00**

Kit fissaggio standard singolo passante (P8) / standard passing fixing kit (P8)

Montaggio / Assembly

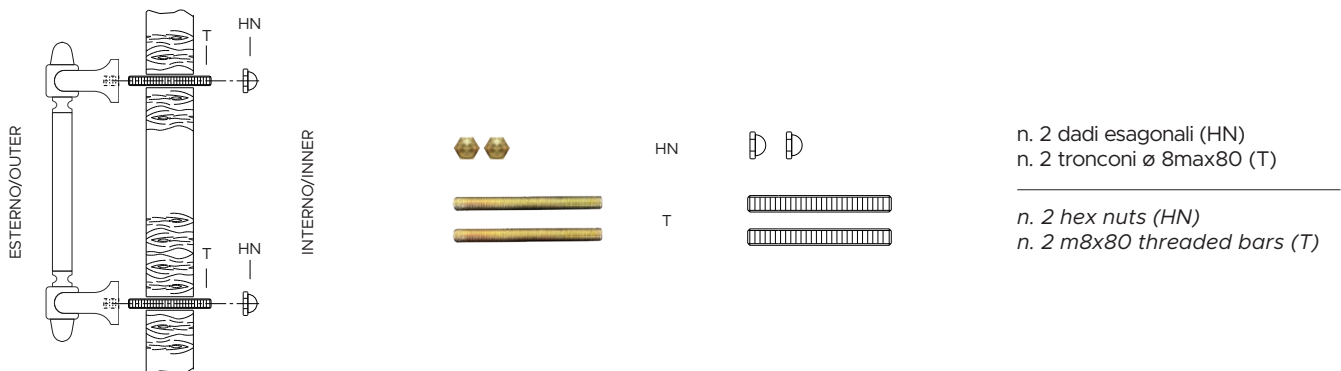

**FISS01**

Kit di fissaggio singolo invisibile per porte in legno / Invisible single fixing kit for wooden doors

Montaggio / Assembly

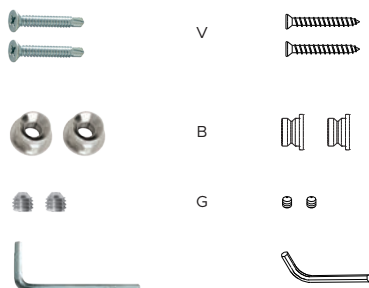
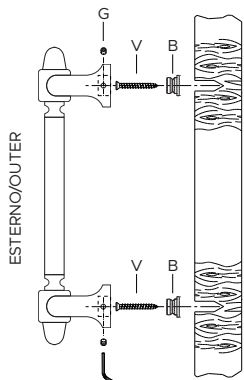

- n. 2 viti autofilettanti (V)
- n. 2 bussole (B)
- n. 2 grani (G)
- n. 1 chiave esagonale

**FISS02A.OT**

Kit di fissaggio per paio / Fixing kit for pair

Montaggio / Assembly

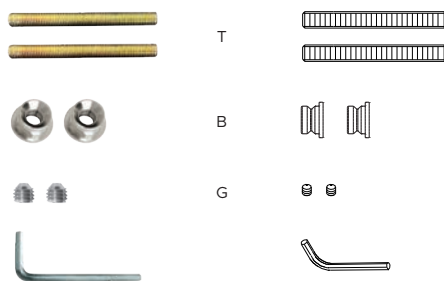
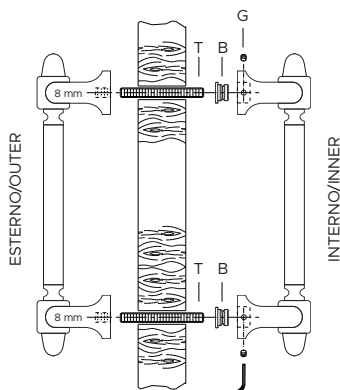

- n. 2 tronconi  $\varnothing$  8max80 (T)
- n. 2 bussole (B)
- n. 2 grani (G)
- n. 1 chiave esagonale

**FISS14**

Kit fissaggio singolo passante (P14) / single standard fixing kit (P14)

Montaggio / Assembly

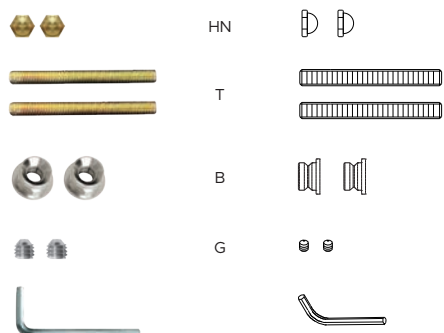
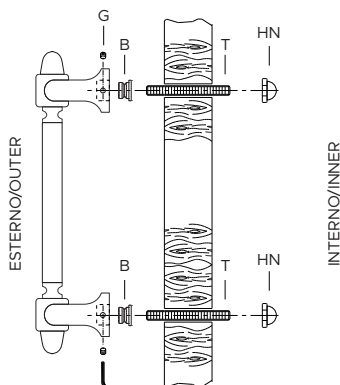

- n. 2 dadi esagonali (HN)
- n. 2 tronconi  $\varnothing$  8max80 (T)
- n. 2 bussole (B)
- n. 2 grani (G)
- n. 1 chiave esagonale

- n. 2 hex nuts (HN)
- n. 2 m8x80 threaded bars (T)
- n. 2 bolts (B)
- n. 2 grub screws (G)
- n. 1 hexagonal key

1320 AL

zama / zinc

168 AL

zama / zinc



Maniglione alzante.  
Lift & slide window handle.



fresatura per nicchia  
milling for flush handle

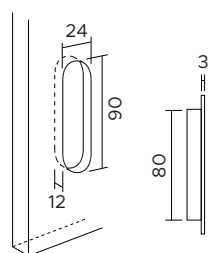
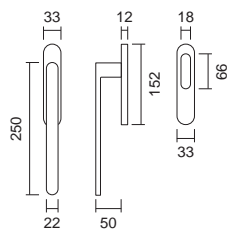

Maniglione alzante.  
Lift & slide window handle.



fresatura per nicchia  
milling for flush handle

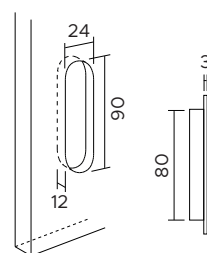
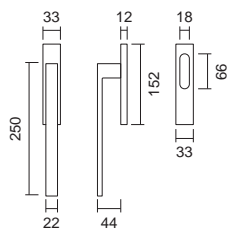

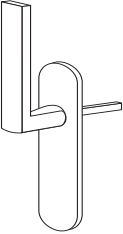
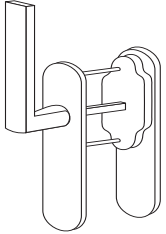
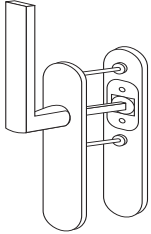
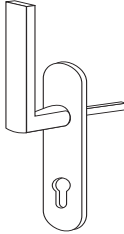
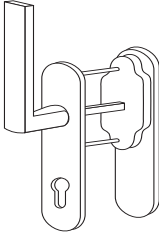
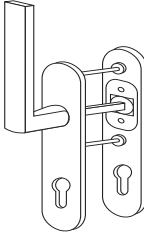
 <p><b>AL 01</b> alzante. lift and slide window handle.</p>	 <p><b>AL 02</b> alzante con nicchia. lift and slide window handle with flush niche.</p>	 <p><b>AL 03</b> coppia alzanti. pair of lift and slide window handles.</p>	 <p><b>AL 04</b> alzante con foro cilindro. lift and slide window handle with cylinder hole plate.</p>	 <p><b>AL 05</b> alzante foro cilindro con nicchia. lift and slide window handle with cylinder hole plate and flush niche.</p>	 <p><b>AL 06</b> coppia alzanti con foro cilindro. pair of lift and slide window handles with cylinder hole plate.</p>
--	---	--	---	---	---

3720 ottone / brass 3705 ottone / brass



Battente.  
Knocker.

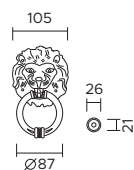

Battente.  
Knocker.

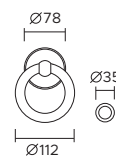

NUMERI CIVICI E LETTERE / HOUSE NUMBERS AND LETTERS

4022 ottone / brass 4023 ottone / brass



Numero civico  
h. 50 mm con pioli.

*h. 50 mm  
house number  
with pins.*

- 0 - 4022.00
- 1 - 4022.01
- 2 - 4022.02
- 3 - 4022.03
- 4 - 4022.04
- .....



Lettere  
h. 50 mm con pioli.

*h. 50 mm  
house letter  
with pins.*

- A - 4023.0A
- B - 4023.0B
- C - 4022.0C
- D - 4023.0D
- .....

GANCI APPENDIABITI/ COAT HANGERS

3702K01 zama / zinc 3702K02 zama / zinc



Gancio appendiabito  
singolo.  
*Coat single hanger.*

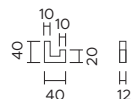

Gancio appendiabito  
doppio.  
*Coat double hanger.*

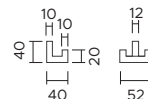

**306KS/201**

zama / zinc

**306/201**

zama / zinc



decentrato / offset

Pomolo con rosetta clip, sottorosetta in plastica.  
 □ 8 disponibile fisso e girevole.  
*Knob with clip rose and PVC under-construction.  
 8x8 mm square hole.  
 Available with fixed and turnable mounting system.*

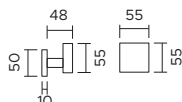

Pomolo con rosetta clip, sottorosetta in plastica.  
 □ 8 disponibile fisso e girevole.  
*Knob with clip rose and PVC under-construction.  
 8x8 mm square hole.  
 Available with fixed and turnable mounting system.*

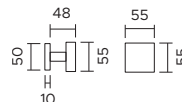

**328GK/273**

zama / zinc

**328/273**

zama / zinc



decentrato / offset

Pomolo con rosetta clip, sottorosetta in plastica.  
 □ 8 disponibile fisso e girevole.  
*Knob with clip rose and PVC under-construction.  
 8x8 mm square hole.  
 Available with fixed and turnable mounting system.*

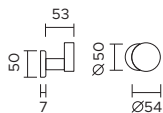

Pomolo con rosetta clip, sottorosetta in plastica.  
 □ 8 disponibile fisso e girevole.  
*Knob with clip rose and PVC under-construction.  
 8x8 mm square hole.  
 Available with fixed and turnable mounting system.*

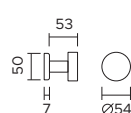

**326Ø60/273**

ottone / brass

**326/273**

ottone / brass



Pomolo con rosetta clip, sottorosetta in plastica.  
 Disponibile fisso e girevole.  
*Knob with clip rose and PVC under-construction.  
 Available with fixed and turnable mounting system.*

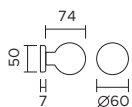

Pomolo con rosetta clip, sottorosetta in plastica.  
 Disponibile fisso e girevole.  
*Knob with clip rose and PVC under-construction.  
 Available with fixed and turnable mounting system.*

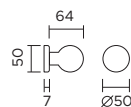

**308/273**

zama / zinc

**350/273**

ottone / brass



decentrato / offset

Pomolo con rosetta clip, sottorosetta in plastica.  
 □ 8 disponibile fisso e girevole.  
*Knob with clip rose and PVC under-construction.  
 8x8 mm square hole.  
 Available with fixed and turnable mounting system.*

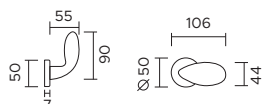

Pomolo con rosetta clip, sottorosetta in plastica.  
 □ 8 disponibile fisso e girevole.  
*Knob with clip rose and PVC under-construction.  
 8x8 mm square hole.  
 Available with fixed and turnable mounting system.*

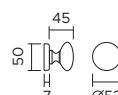

**3688** zama / zinc **3695** ottone / brass **3696** ottone / brass



Fermaporta.  
Door stopper.



Fermaporta.  
Door stopper.



Fermaporta.  
Door stopper.

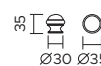

**3687** zama / zinc **3690** zama / zinc



Fermaporta.  
Door stopper.



Fermaporta.  
Door stopper.

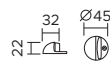

COPRICERNIERE/ OVER-HINGES

**3151** ottone / brass **3154** ottone / brass



Copricerniera.  
Hinge cover.

Ø 14 mm  
Ø 15 mm  
Ø 16 mm



Copricerniera.  
Hinge cover.

Ø 14 mm  
Ø 15 mm  
Ø 16 mm  
Ø 20 mm



**3155** ottone / brass **3156** ottone / brass



Copricerniera.  
Hinge cover.

Ø 15 mm



Copricerniera.  
Hinge cover.

Ø 14 mm



302

zama / zinc 310

zama ottone / zinc brass



Nottolino WC.  
WC turn & release.

∅ 6 - 7 - 8 mm

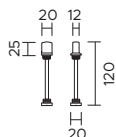

Nottolino WC.  
WC turn & release.

∅ 4 - 6 - 7 - 8 mm

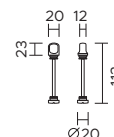

311

zama / zinc 315

ottone / brass



Nottolino WC.  
WC turn & release.

∅ 6 - 7 - 8 mm

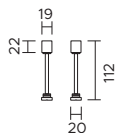

Nottolino WC.  
WC turn & release.

∅ 4 - 6 - 7 - 8 mm

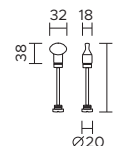

317

zama / zinc 344

ottone / brass



Nottolino WC.  
WC turn & release.

∅ 4 - 6 - 7 - 8 mm

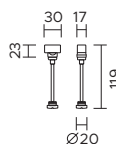

Nottolino WC.  
WC turn & release.

∅ 4 - 6 - 7 - 8 mm

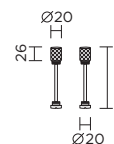

# Kit per porte scorrevoli

Sliding doors flush handles

3667FMTSE6050C

ottone / brass



finiture . finishes  
a richiesta . on request

Paio nicchie foro chiave con trascinatore,  
con serratura chiave e chiave.

Pair of handles with key hole,  
finger sleeve, lock and key.

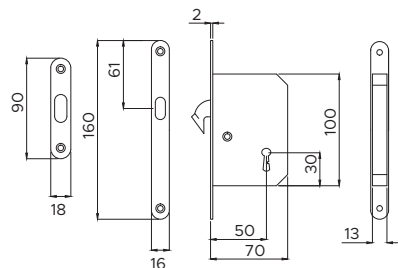
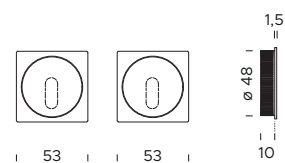
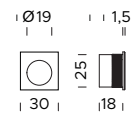

3667FMQ

3667F

ottone / brass



Paio nicchie foro chiave  
con trascinatore.

Pair of handles with key hole  
and finger sleeve.



Paio nicchie foro chiave.

Pair of handles with  
key hole.

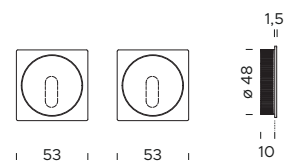
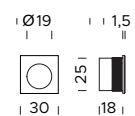

3667ZMQSE6250

ottone / brass



finiture . finishes  
a richiesta . on request

Paio nicchie foro yale con trascinato,  
con serratura cilindro.

Pair of handles with cylinder  
hole, finger sleeve and lock.

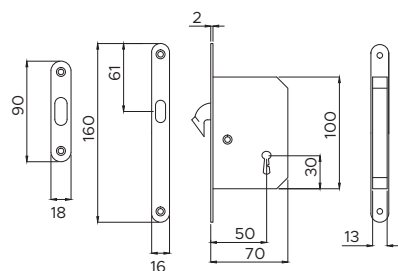
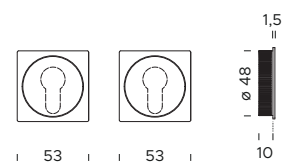
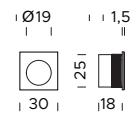

3667ZMQ

3667Z

ottone / brass



Paio nicchie foro cilindro  
con trascinato.  
Pair of handles with cylinder hole  
and finger sleeve.



Paio nicchie foro cilindro.  
Pair of handles with  
cylinder hole.

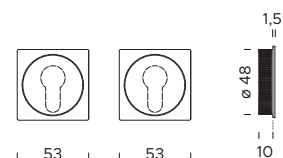
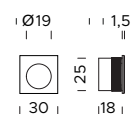

3667RNBMQSE6150

ottone / brass



finiture . finishes  
a richiesta . on request

Paio nicchie foro WC con nottolino ribassato, trascinatore, e serratura WC.

Pair of WC handles with reduced privacy knob, finger sleeve and lock.

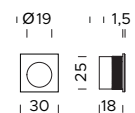

da 42 a 45 mm

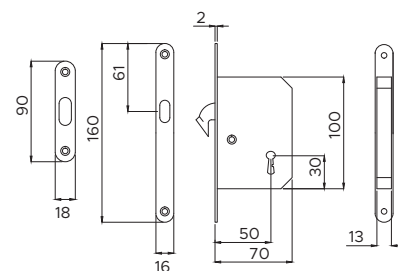
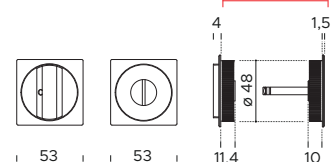

3667RNBMQ

3667RNB

ottone / brass



Paio nicchie foro WC con nottolino ribassato e trascinatore.

Pair of WC handles with reduced privacy knob and finger sleeve.



Paio nicchie foro WC con nottolino ribassato.

Pair of WC handles with reduced privacy knob.

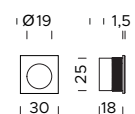

da 42 a 45 mm

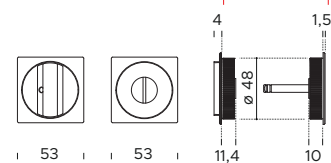

3667CMQ

3667C

ottone / brass



Paio nicchie cieca con trascinatore.  
*Pair of blank handles with finger sleeve.*



Paio nicchie cieca.  
*Pair of blank handles.*

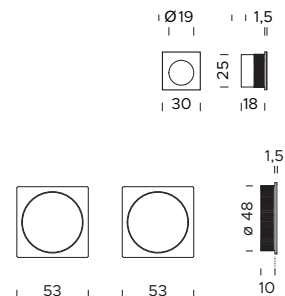

MQ

ottone / brass



Trascinatore.  
*Finger sleeve.*

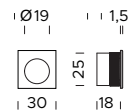

FRESATURA PER PORTE SCORREVOLI / SLIDING DOORS FLUSH HANDLES MILLING

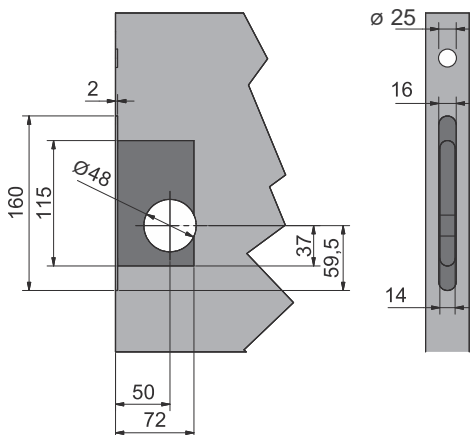

fresatura porta:  $\varnothing$  48 mm  
 tolleranza: + 0,4 mm / - 0,1 mm

door milling:  $\varnothing$  48 mm  
 tolerance: + 0,4 mm / - 0,1 mm

3666FMTSE6050C

ottone / brass



finiture . *finishes*  
a richiesta . *on request*

Paio nicchie foro chiave con trascinatore,  
con serratura chiave e chiave.

*Pair of handles with key hole,  
finger sleeve, lock and key.*

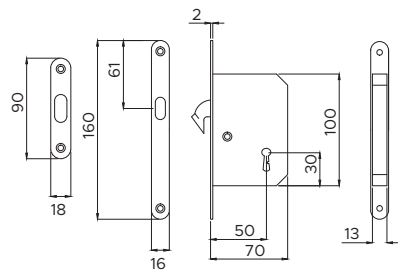
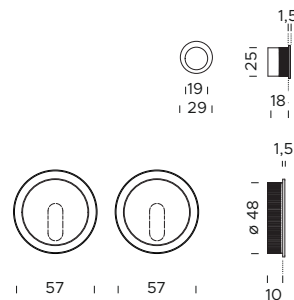

3666FMT

3666F

ottone / brass



Paio nicchie foro chiave  
con trascinatore.  
*Pair of handles with key hole  
and finger sleeve.*



Paio nicchie foro chiave.  
*Pair of handles with  
key hole.*

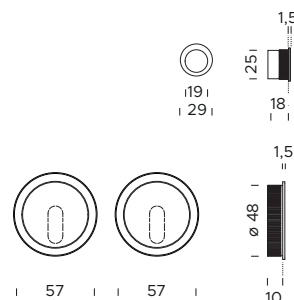

3666ZMTSE6250

ottone / brass



finiture . *finishes*  
a richiesta . *on request*

Paio nicchie foro yale con trascinato,  
con serratura cilindro.

*Pair of handles with cylinder  
hole, finger sleeve and lock.*

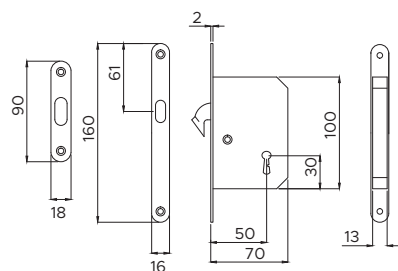
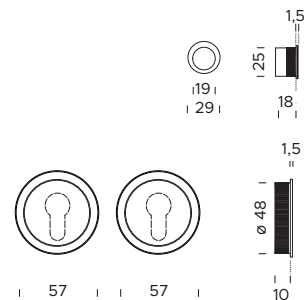

3666ZMT

3666Z

ottone / brass



Paio nicchie foro cilindro  
con trascinato.  
*Pair of handles with cylinder hole  
and finger sleeve.*



Paio nicchie foro cilindro.  
*Pair of handles with  
cylinder hole.*

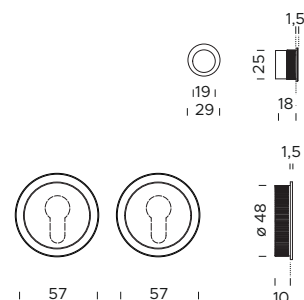

3666RNBMTSE6150

ottone / brass



finiture . finishes  
a richiesta . on request

Paio nicchie foro WC con nottolino ribassato, trascinatore, e serratura WC.

Pair of WC handles with reduced privacy knob, finger sleeve and lock.

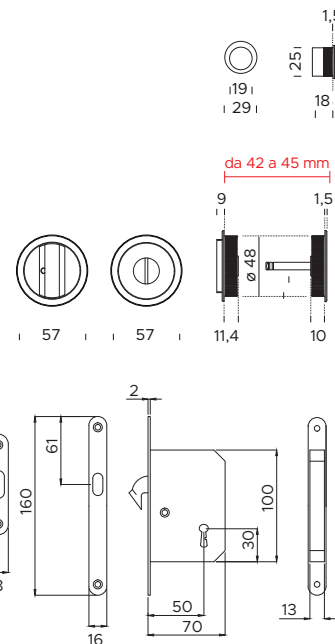

3666RNBMT

3666RNB

ottone / brass



Paio nicchie foro WC con nottolino ribassato e trascinatore.

Pair of WC handles with reduced privacy knob and finger sleeve.



Paio nicchie foro WC con nottolino ribassato.

Pair of WC handles with reduced privacy knob.

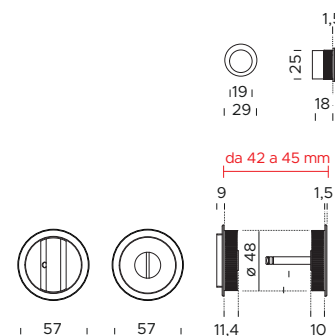

3666CMT

3666C

ottone / brass



Paio nicchie cieca con trascinatore.  
*Pair of blank handles with finger sleeve.*



Paio nicchie cieca.  
*Pair of blank handles.*

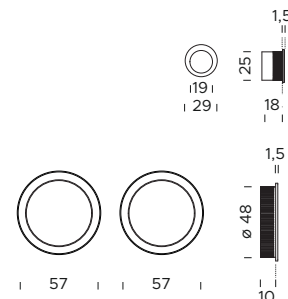

MT

ottone / brass



Trascinatore.  
*Finger sleeve.*

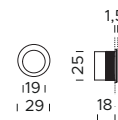

FRESATURA PER PORTE SCORREVOLI / SLIDING DOORS FLUSH HANDLES MILLING

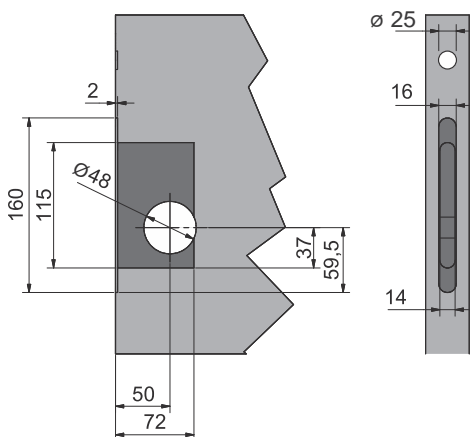

fresatura porta:  $\varnothing$  48 mm  
 tolleranza: + 0,4 mm / - 0,1 mm

door milling:  $\varnothing$  48 mm  
 tolerance: + 0,4 mm / - 0,1 mm

**3665AC**

**3665AR**



Paio nicchie cieca.  
*Pair of blank handles.*

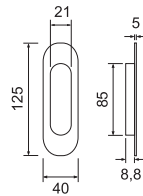

Paio nicchie foro WC.  
*Pair of WC handles.*

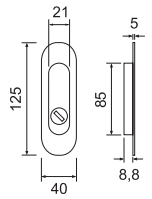

**3665AFB**

**3665AZB**



Paio nicchie foro chiave basso.  
*Pair of handles with bottom key hole.*

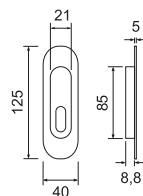

Paio nicchie foro cilindro basso.  
*Pair of handles with bottom cylinder hole.*

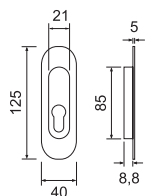

**3663AC**

**3663AR**



Paio nicchie cieca.  
*Pair of blank handles.*

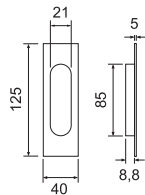

Paio nicchie foro WC.  
*Pair of WC handles.*

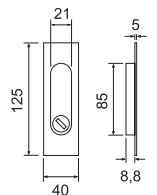

**3663AFB**

**3663AZB**



Paio nicchie foro chiave basso.  
*Pair of handles with  
botton key hole.*

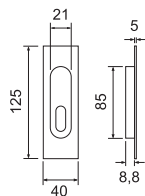

Paio nicchie foro chiave basso.  
*Pair of handles with  
botton cylinder hole.*

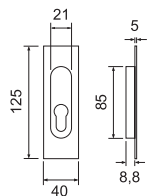

**3665C**

ottone / brass

**3665R**

ottone / brass



Paio nicchie cieca.  
*Pair of blank handles.*

Paio nicchie foro WC.  
*Pair of WC handles.*

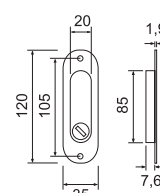
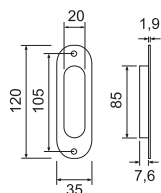

**3665FB**

ottone / brass

**3665ZB**

ottone / brass



Paio nicchie foro chiave.  
*Pair of handles with key hole.*

Paio nicchie foro cilindro.  
*Pair of handles with cylinder hole.*

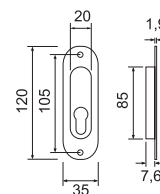
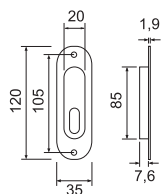

3668

ottone / brass



Paio nicchia cieca.  
Pair of blank handles.

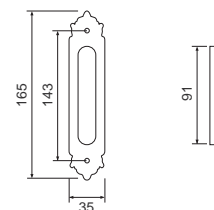

FRESATURA PER PORTE SCORREVOLI / SLIDING DOORS FLUSH HANDLES MILLING

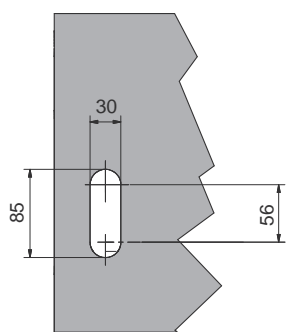

**3665AC / 3665AR / 3665AFB / 3665AZB  
3663AC / 3663AR / 3663AFB / 3663AZB**

fresatura porta: 86x30 mm  
tolleranza: + 0,4 mm / - 0,1 mm

door milling: 86x30 mm  
tolerance: + 0,4 mm / - 0,1 mm

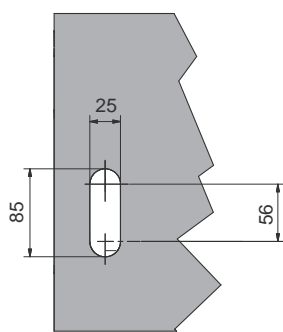

**3665C / 3665R / 3665FB / 3665ZB**

fresatura porta: 86x30 mm  
tolleranza: + 0,4 mm / - 0,1 mm

door milling: 86x30 mm  
tolerance: + 0,4 mm / - 0,1 mm

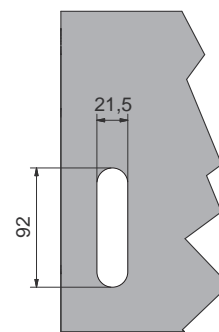

**3668**

fresatura porta: 92x21,5 mm  
tolleranza: + 0,4 mm / - 0,1 mm

door milling: 92x21,5 mm  
tolerance: + 0,4 mm / - 0,1 mm

# Rosette Bocchette Placche Componenti Sistemi di assemblaggio

**Roses / Escutcheons / Plates  
Components  
Assembly systems**

206

ottone o inox / brass or inox

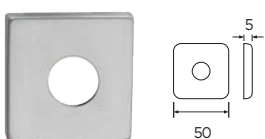

Rosetta.  
Sottorosetta in metallo  
con molla ambidestra.

Rose.  
Metal under-construction  
with built-in spring.



Bocchetta foro chiave.  
Sottorosetta in plastica.

Escutcheon with key hole.  
PVC under-construction.



Bocchetta foro cilindro.  
Sottorosetta in plastica.

Escutcheon with cylinder hole.  
PVC under-construction.



Bocchetta foro wc.  
Sottorosetta in plastica.

Escutcheon with wc hole.  
PVC under-construction.

213 H5

zama / zinc

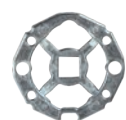
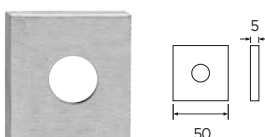

Rosetta.  
Sottorosetta in metallo  
con o senza pioli.

Rose.  
Metal under-construction  
with or without pins.



Bocchetta foro chiave.  
Sottorosetta in plastica.

Escutcheon with key hole.  
PVC under-construction.



Bocchetta foro cilindro.  
Sottorosetta in plastica.

Escutcheon with cylinder hole.  
PVC under-construction.

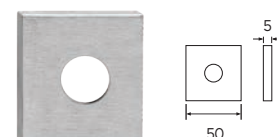

Bocchetta foro wc.  
Sottorosetta in plastica.

Escutcheon with wc hole.  
PVC under-construction.

208 H5

zama / zinc

203 H5

ottone o inox / brass or inox

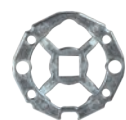
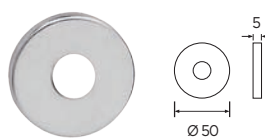

Rosetta.  
Sottorosetta in metallo  
con o senza pioli.

Rose.  
Metal under-construction  
with or without pins.

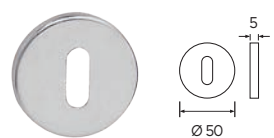

Bocchetta foro chiave.  
Sottorosetta in plastica.

Escutcheon with key hole.  
PVC under-construction.



Bocchetta foro cilindro.  
Sottorosetta in plastica.

Escutcheon with cylinder hole.  
PVC under-construction.

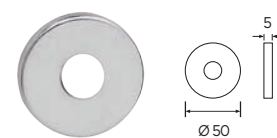

Bocchetta foro wc.  
Sottorosetta in plastica.

Escutcheon with wc hole.  
PVC under-construction.

201

zama / zinc

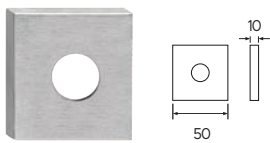

Rosetta.  
Sottorosetta in plastica  
con molla ambidestra.  
*Rose.*  
PVC under-construction.

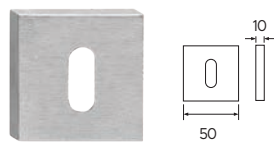

Bocchetta foro chiave.  
Sottorosetta in plastica.  
*Escutcheon with key hole.*  
PVC under-construction.

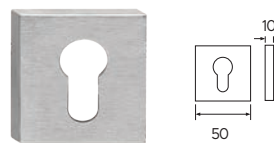

Bocchetta foro cilindro.  
Sottorosetta in plastica.  
*Escutcheon with cylinder hole.*  
PVC under-construction.

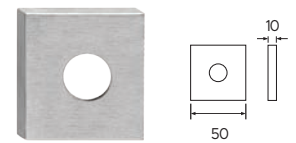

Bocchetta foro wc.  
Sottorosetta in plastica.  
*Escutcheon with wc hole.*  
PVC under-construction.

211B

ottone - ferro - inox / brass - iron - inox

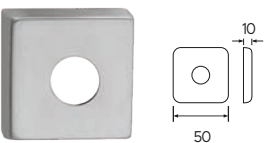

Rosetta.  
Sottorosetta in plastica  
con molla ambidestra.  
*Rose.*  
PVC under-construction.

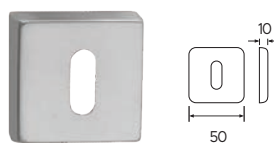

Bocchetta foro chiave.  
Sottorosetta in plastica.  
*Escutcheon with key hole.*  
PVC under-construction.

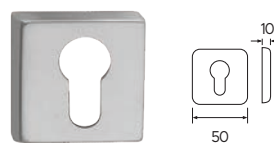

Bocchetta foro cilindro.  
Sottorosetta in plastica.  
*Escutcheon with cylinder hole.*  
PVC under-construction.

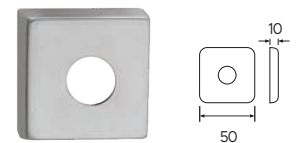

Bocchetta foro wc.  
Sottorosetta in plastica.  
*Escutcheon with wc hole.*  
PVC under-construction.

273MA

ottone - inox / brass - inox



Rosetta.  
Sottorosetta in plastica  
con molla ambidestra.  
*Rose.*  
PVC under-construction.



Bocchetta foro chiave.  
Sottorosetta in plastica.  
*Escutcheon with key hole.*  
PVC under-construction.



Bocchetta foro cilindro.  
Sottorosetta in plastica.  
*Escutcheon with cylinder hole.*  
PVC under-construction.



Bocchetta foro wc.  
Sottorosetta in plastica.  
*Escutcheon with wc hole.*  
PVC under-construction.

232

ottone / brass

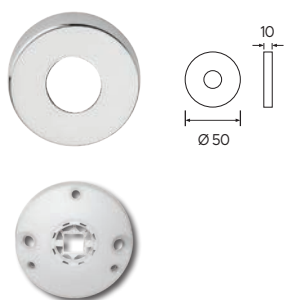

Rosetta.  
Sottorosetta in plastica  
con molla ambidestra.  
*Rose.  
PVC under-construction.*

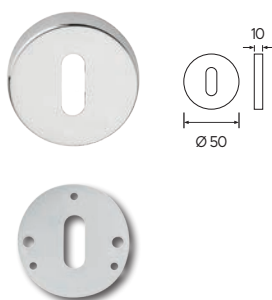

Bocchetta foro chiave.  
Sottorosetta in plastica.  
*Escutcheon with key hole.  
PVC under-construction.*

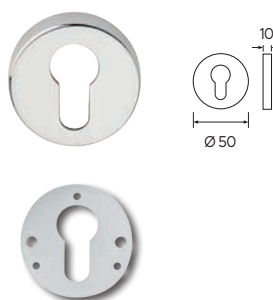

Bocchetta foro cilindro.  
Sottorosetta in plastica.  
*Escutcheon with cylinder hole.  
PVC under-construction.*

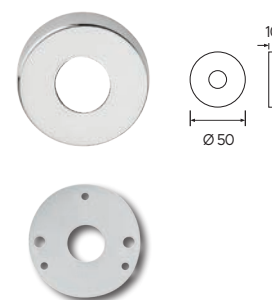

Bocchetta foro wc.  
Sottorosetta in plastica.  
*Escutcheon with wc hole.  
PVC under-construction.*

2233

ottone / brass



Rosetta.  
Sottorosetta in plastica  
con molla ambidestra.  
*Rose.  
PVC under-construction.*

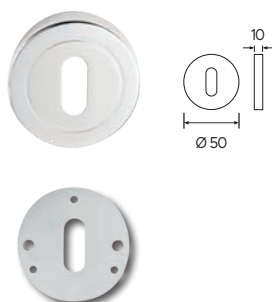

Bocchetta foro chiave.  
Sottorosetta in plastica.  
*Escutcheon with key hole.  
PVC under-construction.*

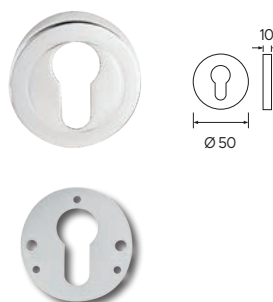

Bocchetta foro cilindro.  
Sottorosetta in plastica.  
*Escutcheon with cylinder hole.  
PVC under-construction.*

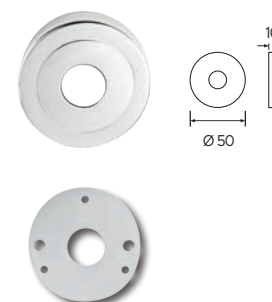

Bocchetta foro wc.  
Sottorosetta in plastica.  
*Escutcheon with wc hole.  
PVC under-construction.*

258

ottone / brass



Rosetta coprivite.  
Sottorosetta in metallo.  
*Screw-rose.  
Metal under-construction.*

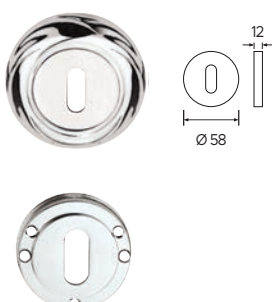

Bocchetta coprivite  
foro chiave.  
Sottorosetta in metallo.  
*Screw-escutcheon  
with key hole.  
Metal under-construction.*



Bocchetta coprivite  
foro cilindro.  
Sottorosetta in metallo.  
*Screw-escutcheon  
with cylinder hole.  
Metal under-construction.*



Bocchetta coprivite  
foro wc.  
Sottorosetta in metallo.  
*Screw-escutcheon  
with wc hole.  
Metal under-construction.*

**231BT**

ottone / brass



Rosetta coprivite.  
Sottorosetta in metallo.

*Screw-rose.  
Metal under-construction.*



Bocchetta coprivite  
foro chiave.  
Sottorosetta in metallo.

*Screw-escutcheon  
with key hole.  
Metal under-construction.*



Bocchetta coprivite  
foro cilindro.  
Sottorosetta in metallo.

*Screw-escutcheon  
with cylinder hole.  
Metal under-construction.*

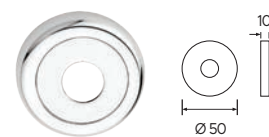

Bocchetta coprivite  
foro wc.  
Sottorosetta in metallo.

*Screw-escutcheon  
with wc hole.  
Metal under-construction.*

**231C**

ottone / brass



Rosetta coprivite.  
Sottorosetta in metallo.

*Screw-rose.  
Metal under-construction.*



Bocchetta coprivite  
foro chiave.  
Sottorosetta in metallo.

*Screw-escutcheon  
with key hole.  
Metal under-construction.*



Bocchetta coprivite  
foro cilindro.  
Sottorosetta in metallo.

*Screw-escutcheon  
with cylinder hole.  
Metal under-construction.*



Bocchetta coprivite  
foro wc.  
Sottorosetta in metallo.

*Screw-escutcheon  
with wc hole.  
Metal under-construction.*

**250F**

ottone / brass



Rosetta coprivite.  
Sottorosetta in metallo.

*Screw-rose.  
Metal under-construction.*



Bocchetta coprivite  
foro chiave.  
Sottorosetta in metallo.

*Screw-escutcheon  
with key hole.  
Metal under-construction.*



Bocchetta coprivite  
foro cilindro.  
Sottorosetta in metallo.

*Screw-escutcheon  
with cylinder hole.  
Metal under-construction.*



Bocchetta coprivite  
foro wc.  
Sottorosetta in metallo.

*Screw-escutcheon  
with wc hole.  
Metal under-construction.*

269

ottone / brass



Rosetta coprivite.  
Sottorosetta in metallo.

*Screw-rose.  
Metal under-construction.*



Bocchetta coprivite  
foro chiave.  
Sottorosetta in metallo.

*Screw-escutcheon  
with key hole.  
Metal under-construction.*



Bocchetta coprivite  
foro cilindro.  
Sottorosetta in metallo.

*Screw-escutcheon  
with cylinder hole.  
Metal under-construction.*

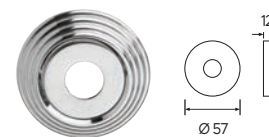

Bocchetta coprivite  
foro wc.  
Sottorosetta in metallo.

*Screw-escutcheon  
with wc hole.  
Metal under-construction.*

266

ottone / brass



Rosetta coprivite.  
Sottorosetta in metallo.

*Screw-rose.  
Metal under-construction.*



Bocchetta coprivite  
foro chiave.  
Sottorosetta in metallo.

*Screw-escutcheon  
with key hole.  
Metal under-construction.*



Bocchetta coprivite  
foro cilindro.  
Sottorosetta in metallo.

*Screw-escutcheon  
with cylinder hole.  
Metal under-construction.*



Bocchetta coprivite  
foro wc.  
Sottorosetta in metallo.

*Screw-escutcheon  
with wc hole.  
Metal under-construction.*

261

ottone / brass



Rosetta coprivite.  
Sottorosetta in metallo.

*Screw-rose.  
Metal under-construction.*



Bocchetta coprivite  
foro chiave.  
Sottorosetta in metallo.

*Screw-escutcheon  
with key hole.  
Metal under-construction.*



Bocchetta coprivite  
foro cilindro.  
Sottorosetta in metallo.

*Screw-escutcheon  
with cylinder hole.  
Metal under-construction.*



Bocchetta coprivite  
foro wc.  
Sottorosetta in metallo.

*Screw-escutcheon  
with wc hole.  
Metal under-construction.*

**239** solo per maniglie art. 1501 e 1502 / available with handles art. 1501 and 1502 only

ottone / brass

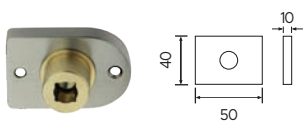

Rosetta.

Rose.

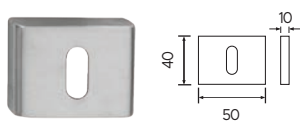

Bocchetta foro chiave.  
Sottorosetta in metallo.

*Escutcheon with key hole.  
Metal under-construction.*

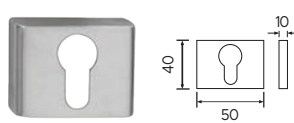

Bocchetta foro cilindro.  
Sottorosetta in metallo.

*Escutcheon with cylinder hole.  
Metal under-construction.*

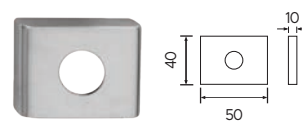

Bocchetta foro wc.  
Sottorosetta in metallo.

*Escutcheon with wc hole.  
Metal under-construction.*

**264**

zama / zinc

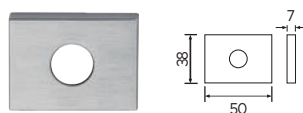

Rosetta.  
Sottorosetta in plastica con molla ambidestra.

*Rose.  
PVC under-construction.*

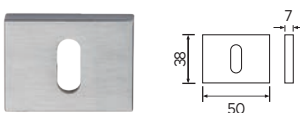

Bocchetta foro chiave.  
Sottorosetta in plastica.

*Escutcheon with key hole.  
PVC under-construction.*

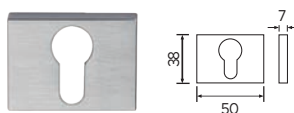

Bocchetta foro cilindro.  
Sottorosetta in plastica.

*Escutcheon with cylinder hole.  
PVC under-construction.*



Bocchetta foro WC.  
Sottorosetta in plastica.

*Escutcheon with WC hole.  
PVC under-construction.*

**211BIC**

ottone o zama / brass or zinc

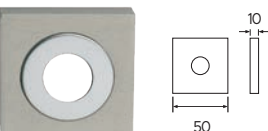

Rosetta coprivite.  
Sottorosetta in metallo.

*Screw-rose.  
Metal under-construction.*

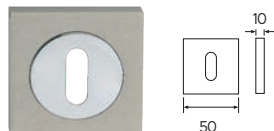

Bocchetta coprivite foro chiave.  
Sottorosetta in metallo.

*Screw-escutcheon with key hole.  
Metal under-construction.*

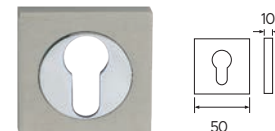

Bocchetta coprivite foro cilindro.  
Sottorosetta in metallo.

*Screw-escutcheon with cylinder hole.  
Metal under-construction.*

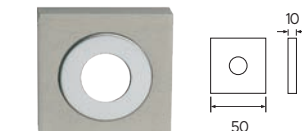

Bocchetta coprivite foro WC.  
Sottorosetta in metallo.

*Screw-escutcheon with WC hole.  
Metal under-construction.*

294

ottone / brass

<p>Rosetta.</p>	<p>Bocchetta oro chiave.</p>	<p>Bocchetta foro cilindro.</p>	<p>Bocchetta foro wc.</p>
<p>Rose.</p>	<p><i>Escutcheon with key hole.</i></p>	<p><i>Escutcheon with cylinder hole.</i></p>	<p><i>Escutcheon with wc hole.</i></p>

<p><b>2067.18</b></p>	<p><b>2068.BL</b></p>	<p><b>2068.BBT</b></p>	<p><b>2070.PZ</b> ottone / brass</p>
<p>Rosetta coprivite. Sottorosetta in metallo.</p>	<p>Bocchetta coprivite cieca. Sottorosetta in metallo.</p>	<p>Bocchetta coprivite con foro chiave tedesco. Sottorosetta in metallo.</p>	<p>Bocchetta coprivite con foro cilindro. Sottorosetta in metallo.</p>
<p><i>Screw-rose. Metal under-construction.</i></p>	<p><i>Blank screw-escutcheon. Metal under-construction.</i></p>	<p><i>Screw-escutcheon with german key hole. Metal under-construction.</i></p>	<p><i>Screw-escutcheon with cylinder hole. Metal under-construction.</i></p>

<p><b>2167.18</b></p>	<p><b>2168.BL</b></p>	<p><b>2168.BBT</b></p>	<p><b>2170.PZ</b> ottone / brass</p>
<p>Rosetta coprivite. Sottorosetta in metallo.</p>	<p>Rosetta coprivite cieca. Sottorosetta in metallo.</p>	<p>Bocchetta coprivite con foro chiave tedesco. Sottorosetta in metallo.</p>	<p>Bocchetta coprivite con foro cilindro. Sottorosetta in metallo.</p>
<p><i>Screw-rose. Metal under-construction.</i></p>	<p><i>Blank screw-rose. Metal under-construction.</i></p>	<p><i>Screw-escutcheon with german key hole. Metal under-construction.</i></p>	<p><i>Screw-escutcheon with cylinder hole. Metal under-construction.</i></p>

243 MINI

zama / zinc



Rosetta.

Rose.



Bocchetta  
foro chiave.

*Escutcheon  
with key hole.*



Bocchetta  
foro cilindro.

*Escutcheon  
with cylinder hole.*



Bocchetta  
foro wc.

*Escutcheon  
with wc hole.*

241 MINI

ottone o zama / brass or zinc



Rosetta.

Rose.



Bocchetta  
foro chiave.

*Escutcheon  
with key hole.*

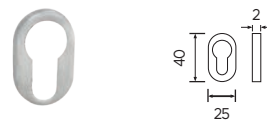

Bocchetta  
foro cilindro.

*Escutcheon  
with cylinder hole.*



Bocchetta  
foro wc.

*Escutcheon  
with wc hole.*

244 MINI

ottone o zama / brass or zinc



Rosetta.

Rose.



Bocchetta  
foro chiave.

*Escutcheon  
with key hole.*

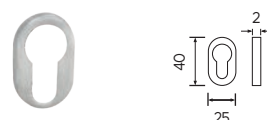

Bocchetta  
foro cilindro.

*Escutcheon  
with cylinder hole.*



Bocchetta  
foro wc.

*Escutcheon  
with wc hole.*

SCASSO PER PORTA / DOOR DRILLING

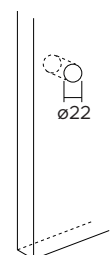

Rosetta.

Rose.

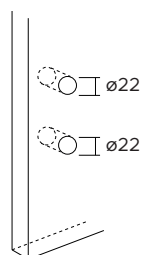

Bocchetta foro chiave.

*Escutcheon with key hole.*

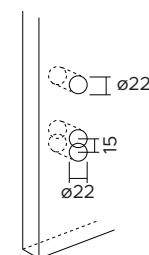

Bocchetta foro cilindro.

*Escutcheon with cylinder hole.*

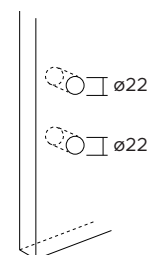

Bocchetta foro wc.

*Escutcheon with wc hole.*

276

inox - ottone / inox - brass

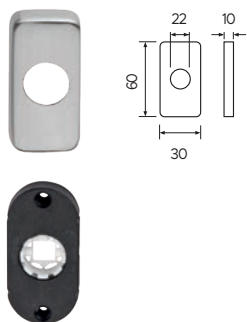

Rosetta.  
Sottorosetta in plastica.

Rose.  
PVC under-construction.

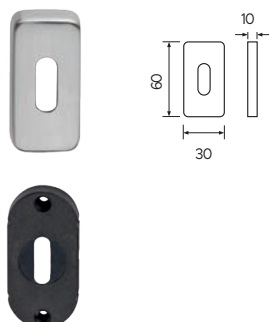

Bocchetta foro chiave.  
Sottorosetta in plastica.

Escutcheon with key hole.  
PVC under-construction.

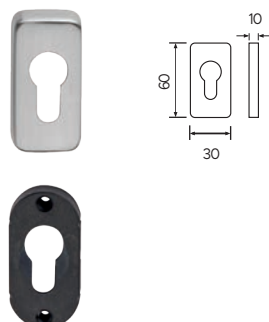

Bocchetta foro cilindro.  
Sottorosetta in plastica.

Escutcheon with cylinder hole.  
PVC under-construction.

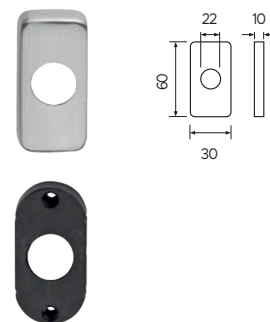

Bocchetta foro wc.  
Sottorosetta in plastica.

Escutcheon with wc hole.  
PVC under-construction.

277

inox - ottone / inox - brass

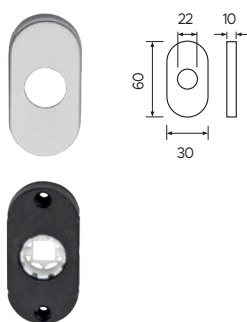

Rosetta.  
Sottorosetta in plastica.

Rose.  
PVC under-construction.

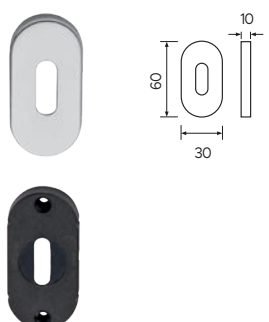

Bocchetta foro chiave.  
Sottorosetta in plastica.

Escutcheon with key hole.  
PVC under-construction.

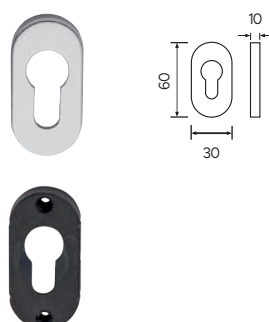

Bocchetta foro cilindro.  
Sottorosetta in plastica.

Escutcheon with cylinder hole.  
PVC under-construction.

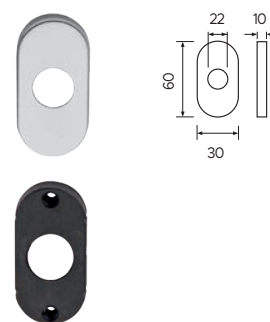

Bocchetta foro wc.  
Sottorosetta in plastica.

Escutcheon with wc hole.  
PVC under-construction.

276 DKR

277 DK

278 DK

282 DK.A ottone / brass

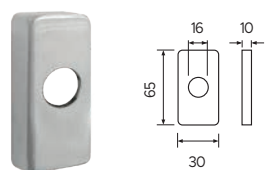

Rosetta DK.  
DK cover.

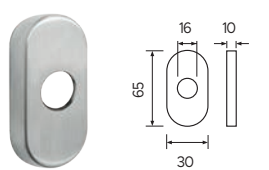

Rosetta DK.  
DK cover.

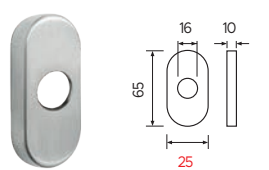

Rosetta DK stretto.  
Narrow DK cover.

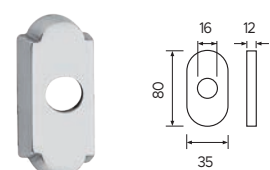

Rosetta DKA.  
DKA cover.

DKS

inox - ottone / inox - brass

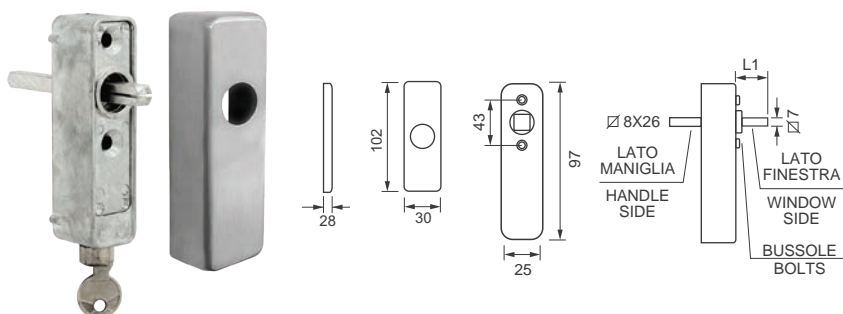

codice code	L1	scatti positions
DKS35COP	35	⊕
DKS42COP	42	⊕

rosetta DKS e meccanismo in metallo con bussole e chiave.  
DKS cover with metal mechanism with bolts and key.

**202L** ottone inox ferro / brass inox iron **205** ottone ferro / brass iron **275R** ottone / brass **248P** ottone / brass

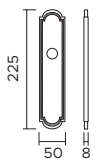
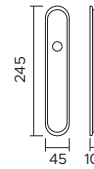
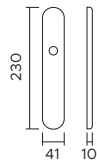
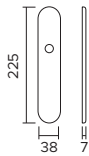

**293** ottone / brass **257** ottone / brass **288** ottone / brass **280** ottone / brass

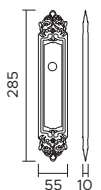
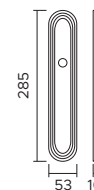
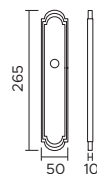
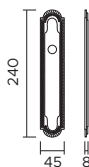

disponibili nei vari fori e distanze (c/c da specificare)  
available with different holes and distances (c/c to specify)



più finiture a richiesta / more finishes upon request

**228** ottone / brass **296** ottone / brass **296M** ottone / brass **250A** ottone / brass **217** ottone / brass **217S** ottone / brass

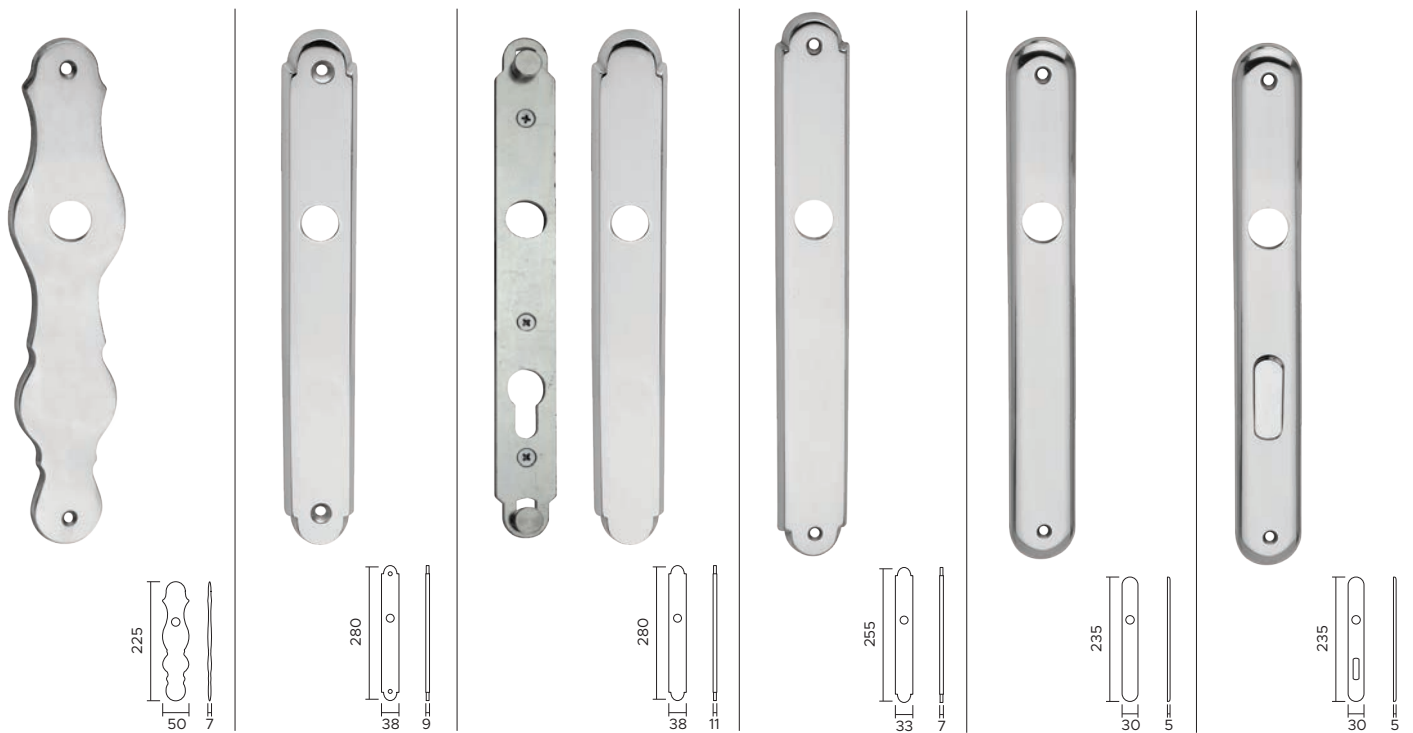

**246** ottone / brass **274** ottone / brass **209** zama / zinc **210** ottone / brass **216** alluminio / aluminum



disponibili nei vari fori e distanze (c/c da specificare)  
available with different holes and distances (c/c to specify)



più finiture a richiesta / more finishes upon request

**070BU4**

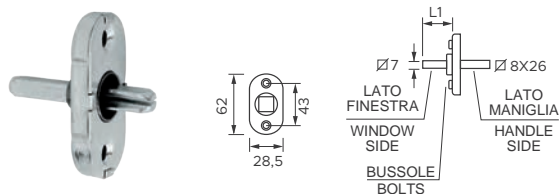

meccanismo DK  
in metallo con bussole  
*metal DK  
mechanism with bolts*

codice/code	L1	4 scatti 4 positions
070BU4.32	32	⊕
070BU4.35	35	⊕
070BU4.42	42	⊕

**070BU8**

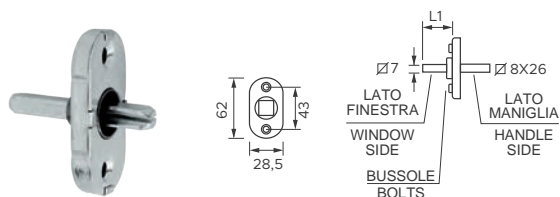

meccanismo DK  
in metallo con bussole  
*metal DK  
mechanism with bolts*

codice/code	L1	8 scatti 8 positions
070BU8.62	62	⊕

**080BU4**

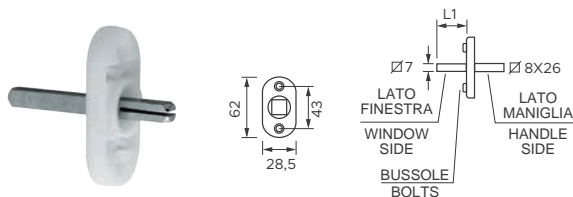

meccanismo DK  
in resina con bussole  
*resin DK  
mechanism with bolts*

codice/code	L1	4 scatti 4 positions
080BU4.35	35	⊕

**078BU4**

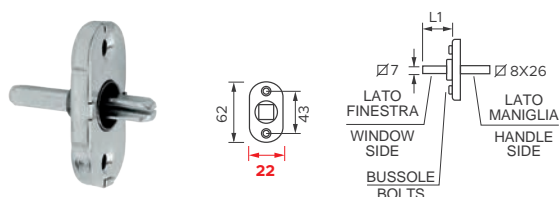

meccanismo DK stretto  
in metallo con bussole  
*metal narrow DK  
mechanism with bolts*

codice/code	L1	2 scatti 2 positions
078BU4.40	40	⊕

**MECCCRE057BU**

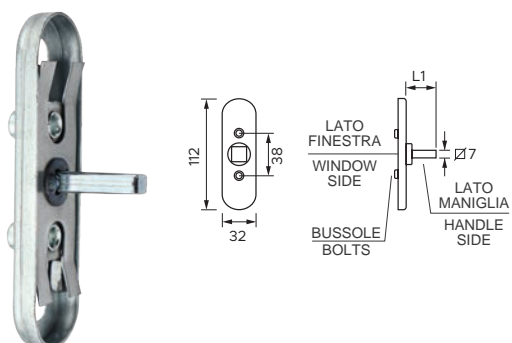

meccanismo per cremone  
gratz in metallo con bussole  
*mechanism for window  
handle 057 with round bolts*

codice/code	L1
MECCCRE057BU	23

## 0001



Ferro  $\square$  7 mm normale.

*Standard  $\square$  7 mm square spindle.*

0001.07.90  $\square$  7x90

## 0003 - 0004



Ferro  $\square$  7 mm con fresature.

*$\square$  7 mm square spindle with two cuts and two millings.*

0003.07.85  $\square$  7x85  
 0003.07.90  $\square$  7x90  
 0003.07.95  $\square$  7x95  
 0003.07.110  $\square$  7x110

Ferro  $\square$  8 mm con fresature.

*$\square$  8 mm square spindle with two cuts and two millings.*

0004.08.80  $\square$  8x80  
 0004.08.85  $\square$  8x85  
 0004.08.90  $\square$  8x90  
 0004.08.95  $\square$  8x95  
 0004.08.100  $\square$  8x100  
 0004.08.105  $\square$  8x105  
 0004.08.110  $\square$  8x110  
 0004.08.120  $\square$  8x120  
 0004.08.130  $\square$  8x130  
 0004.08.140  $\square$  8x140  
 0004.08.160  $\square$  8x160

## 0005

MOQ = 100 PCS



Ferro con doppio  $\square$  8-9 mm.

*Double squared  $\square$  8-9 mm square spindle.*

0005.08.120.40  $\square$  da 8 a 8,5  
 0005.08.120.50  $\square$  da 8 a 9

## 0006

MOQ = 100 PCS



Ferro  $\square$  8 mm doppio snodabile per privacy.

*Swivel double squared  $\square$  8 mm square spindle.*

0006.08.120  $\square$  8x90

## 0007

## 0008



Ferro  $\square$  8 mm ad espansione.

*Expanding  $\square$  8 mm square spindle.*

0007.08.55  $\square$  8x55  
 0007.08.70  $\square$  8x70  
 0007.08.80  $\square$  8x80  
 0007.08.90  $\square$  8x90



Ferro  $\square$  8 mm con gole.

*Square  $\square$  8 mm spindle with notches.*

0008.08.57  $\square$  8x57

**0011 FILETTO M10 - 0012 FILETTO M12** 100 pezzi / 100 pieces

**0013**  $\varnothing 8$

100 pezzi / 100 pieces



Ferro  $\varnothing 8$  mm per pomolo fisso con filetto e maniglia girevole.

$\varnothing 8$  mm spindle with threaded head (suitable for fixed knob and turnable handle).

0011.08.90	$\varnothing 8 \times 100$	M10 ES13
0011.08.120	$\varnothing 8 \times 120$	M10 ES13
0011.08.140	$\varnothing 8 \times 140$	M10 ES13

0012.08.70	$\varnothing 8 \times 70$	M12 ES13
0012.08.80	$\varnothing 8 \times 80$	M12 ES13
0012.08.90	$\varnothing 8 \times 90$	M12 ES13
0012.08.100	$\varnothing 8 \times 100$	M12 ES13
0012.08.120	$\varnothing 8 \times 120$	M12 ES13
0012.08.140	$\varnothing 8 \times 140$	M12 ES13



Ferro  $\varnothing 8$  mm per pomolo fisso con  $\varnothing 8$  + maniglia girevole.

$\varnothing 8$  mm spindle with  $\varnothing$  spindle + turnable handle.

0013.Q8.80	$\varnothing 8 \times 80$
0013.Q8.100	$\varnothing 8 \times 100$
0013.Q8.110	$\varnothing 8 \times 110$
0013.Q8.130	$\varnothing 8 \times 130$

**0014**  $\varnothing 8$

100 pezzi / 100 pieces

**0014 FILETTO M8**

100 pezzi / 100 pieces



Ferro  $\varnothing 8$  mm per pomolo fisso con quadro e maniglia girevole.

$\varnothing 8$  mm spindle with  $\varnothing$  and square spindle + turnable handle.

0014.Q8.90	$\varnothing 8 \times 90$
0014.Q8.100	$\varnothing 8 \times 100$
0014.Q8.110	$\varnothing 8 \times 110$
0014.Q8.130	$\varnothing 8 \times 130$



Ferro  $\varnothing 8$  mm per pomolo fisso con filetto e maniglia girevole.

$\varnothing 8$  mm spindle with  $\varnothing$  and m8 thread + turnable handle.

0014.M8.90	$\varnothing 8 \times 90$
0014.M8.100	$\varnothing 8 \times 100$
0014.M8.110	$\varnothing 8 \times 110$
0014.M8.130	$\varnothing 8 \times 130$

**0031.35**

100 pezzi / 100 pieces

**0032.35**

100 pezzi / 100 pieces

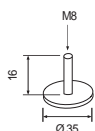

Piastrina  $\varnothing 35$  con perno filettato m8x16.  
 $\varnothing 35$  plate with m8x16 threaded pin.

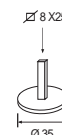

Piastrina  $\varnothing 35$  con  $\varnothing 8 \times 25$ .  
 $\varnothing 35$  plate with 8x25 spindle.

**0033.44**

100 pezzi / 100 pieces

**0034.44**



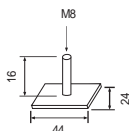



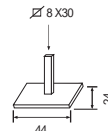

100 pezzi / 100 pieces



Piastrina 44x24 con perno filettato m8x16.  
44x24 plate with m8x16 threaded pin.



Piastrina 44x24 con  $\varnothing 8 \times 30$ .  
44x24 plate with 8x26 spindle.

<p><b>0041</b> 100 pezzi / 100 pieces</p>  <p>Riduzione in ferro. <i>Metal adapter.</i></p> <p>0041.67.30 da 6 a 7 mm lunghezza/length 30 mm</p> <p>0041.68.20 da 6 a 8 mm lunghezza/length 30 mm</p> <p>0041.78.30 da 7 a 8 mm lunghezza/length 30 mm</p> <p>0041.810.30 da 8 a 10 mm lunghezza/length 30 mm</p> <p>0041.885.30 da 8 a 8,5 mm lunghezza/length 30 mm</p> <p>0041.89.30 da 8 a 9 mm lunghezza/length 30 mm</p>	<p><b>0042</b> 100 pezzi / 100 pieces</p>  <p>Molla a chiocciola. <i>Spiral shape spring.</i></p> <p>0042.02 spessore/thickness 2 mm</p> <hr/> <p><b>0043</b> 100 pezzi / 100 pieces</p>  <p>Piastrina fermamolla. <i>One - hook spring block.</i></p> <p>0043.12 spessore/thickness 1,2 mm</p>
<p><b>0044</b> 100 pezzi / 100 pieces</p>  <p>Piastrina fermamolla 2 ganci. <i>Two - hooks spring block.</i></p> <p>0044.01 spessore/thickness 1 mm</p>	<p><b>0045</b> 100 pezzi / 100 pieces</p>  <p>Anello seeger DIN 471. <i>DIN 471 seeger.</i></p> <p>0045.138 ø interno/inner 13,8 mm</p>
<p><b>0046</b> 100 pezzi / 100 pieces</p>  <p>Guarnizione con testa. <i>Gasket with shoulder.</i></p> <p>0046.1618.6.PT ø testa esterno/outer 20mm</p> <p>ø interno/inner 16 mm ø esterno/outer 18 mm spessore/thickness 0,8 mm h. totale/total h. 6 mm</p> <p>Guarnizione piatta nylon. <i>Flat nylon gasket.</i></p>  <p>0046.1619.05 ø interno/inner 16 mm ø esterno/outer 19 mm spessore/thickness 0,5 mm</p> <p>0046.1619.1 ø interno/inner 16 mm ø esterno/outer 19 mm spessore/thickness 1 mm</p> <p>0046.1621.1 ø interno/inner 16 mm ø esterno/outer 21 mm spessore/thickness 1 mm</p>	<p><b>0048</b> 100 pezzi / 100 pieces</p>  <p>Rondella piatta ferro. <i>Flat iron washer.</i></p> <p>0048.1620.05 ø interno/inner 16 mm ø esterno/outer 20 mm spessore/thickness 0,5 mm</p> <hr/> <p><b>0049</b> 100 pezzi / 100 pieces</p>  <p>Rondella ondulata acciaio. <i>Corrugated steel washer.</i></p> <p>0049.1620.04 ø interno/inner 16 mm ø esterno/outer 20 mm spessore/thickness 0,4 mm</p>

**0061.KIT01**

100 pezzi / 100 pieces



4 viti 2,5x16 mm  
4 2,5x16 mm screws

**0061.KIT02**

100 pezzi / 100 pieces



2 grani M6x6  
1 chiave 3 mm

2 M6x6 grub screws  
1 allen key 3 mm

**0061.KIT03**

100 pezzi / 100 pieces



4 viti 3,5x25 mm  
2 grani M6x6  
1 chiave 3 mm

4 3,5x25 mm screws  
2 M6x6 grub screws  
1 allen key 3 mm



0061.KIT03.01  
viti ottonate / brass screws  
0061.KIT03.03  
viti bronzate / bronzed screws  
0061.KIT03.21  
viti nickelate / nickel screws  
0061.KIT03.35N  
viti zincate nere / black galvanized screws

**0061.KIT04**

100 pezzi / 100 pieces



10 viti 2,5x16 mm  
2 grani M6x7 a punta  
2 guarnizioni piatta nylon  
ø interno 16 mm  
ø esterno 19 mm  
spessore 0,5 mm  
1 chiave 3 mm



10 2,5x16 mm screws  
2 M6x7 pointed grub screws  
2 flat nylon gaskets  
ø inner 16 mm  
ø outer 19 mm  
thickness 0,5 mm  
1 allen key 3 mm

**0061.KIT05**

100 pezzi / 100 pieces



6 viti 2,5x16 mm  
1 grano M6x7 a punta  
2 guarnizioni piatta nylon  
ø interno 16 mm  
ø esterno 19 mm  
spessore 0,5 mm  
1 riduzione 6-7 mm 30  
1 riduzione 6-8 mm 20



6 2,5x16 mm screws  
1 M6x7 pointed grub screws  
2 flat nylon gaskets  
ø inner 16 mm  
ø outer 19 mm  
thickness 0,5 mm  
1 6-7 mm 30 adapter  
1 6-8 mm 20 adapter

**0061.KIT06**

100 pezzi / 100 pieces



10 viti 2,5x25 mm  
4 viti 4x50 mm  
1 riduzione 8-8,5 mm 30  
1 riduzione 9-8 mm 30  
1 chiave 3 mm



10 2,5x25 mm screws  
4 4x50 mm screws  
1 8-8,5 mm 30 adapter  
1 9-8 mm 30 adapter  
1 allen key 3 mm



**0061.KIT07**

100 pezzi / 100 pieces



2 viti M3x50 mm  
2 bussole M3x20 mm  
taglio cacciavite

2 M3x50 mm screws  
2 M3x20 mm bolts  
screwdriver cut

**0061.KIT08**

100 pezzi / 100 pieces



4 viti M4x40 mm  
4 bussole M4x20 mm  
2 guarnizioni piatta nylon  
ø interno 16 mm  
ø esterno 19 mm  
spessore 0,5 mm  
2 grani M6x6  
1 chiave 3 mm

4 M4x40 mm screws  
2 M4x20 mm bolts  
2 flat nylon gaskets  
ø inner 16 mm  
ø outer 19 mm  
thickness 0,5 mm  
2 M6x6 grub screws  
1 allen key 3 mm

**0061.KIT09**

100 pezzi / 100 pieces



2 viti M4x60 mm  
2 bussole M4x20 mm

2 M4x60 mm screws  
2 M4x20 mm bolts

**0061.KIT10**

100 pezzi / 100 pieces



2 viti M4x90 mm  
2 bussole M4x20 mm

2 M4x90 mm screws  
2 M4x20 mm bolts

**0061.KIT25**

100 pezzi / 100 pieces



2 viti M5x40 mm  
1 grani M6x7 a punta  
1 guarnizioni piatta nylon  
ø interno 16 mm  
ø esterno 19 mm  
spessore 0,5 mm  
1 chiave 3 mm

2 M4x40 mm screws  
1 M6x7 pointed grub screws  
1 flat nylon gasket  
ø inner 16 mm  
ø outer 19 mm  
thickness 0,5 mm  
1 allen key 3 mm

**0061.KIT62**

100 pezzi / 100 pieces



2 viti M4x40 mm  
2 bussole M4x20 mm  
10 viti 2,5x15 mm  
2 grani M6x7 a punta  
2 guarnizioni piatta nylon  
ø interno 16 mm  
ø esterno 19 mm  
spessore 0,5 mm  
1 chiave 3 mm

2 M4x40 mm screws  
2 M4x20 mm bolts  
10 2,5x15 mm screws  
2 M6x7 pointed grub screws  
2 flat nylon gaskets  
ø inner 16 mm  
ø outer 19 mm  
thickness 0,5 mm  
1 allen key 3 mm

ART. TONDO/ROUND: 230 - 230R - 231 - 232 - 236 - 273MA - ART. QUADRO/SQUARE: 201 - 211B - 215 - 264



Inserire il ferro quadro nella serratura, rivolgendo la fresata o il foro verso la posizione del foro grano presente sulla maniglia.

Insert the square spindle into the lock. The square spindle's milling or the hole has to be pointed to the handle's grub screw hole.

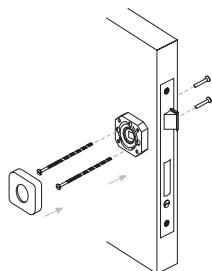
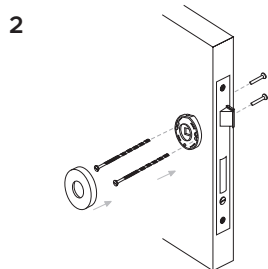

Posizionare la sotto-rosetta (provvista di molla incorporata) in asse con il ferro quadro, fissare con le viti in dotazione. Dopodiché, posizionare la copertina a pressione sulla sotto-rosetta.

Position the built-in spring under-rose aligned with the square spindle, then fasten with the screws. Clip the cover rose on the under-rose.

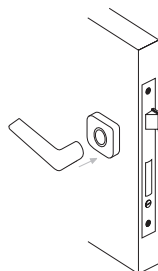
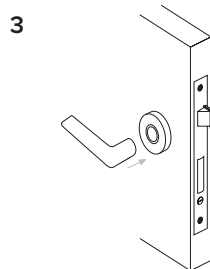

Posizionare la maniglia.

Position the handle.

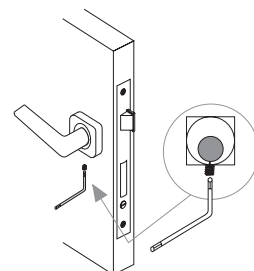
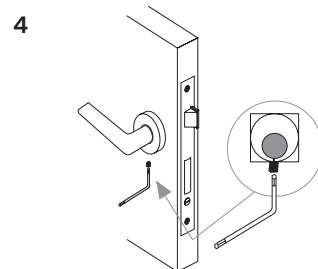

Avvitare il grano della maniglia nell'apposito foro finché non si blocca.

Fasten the grub screw in the handle's designated hole, until it stops.

ART. TONDO/ROUND: 241 - 244 - ART. QUADRO/SQUARE: 243

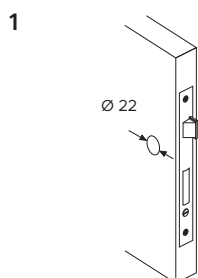

Eseguire un foro di 22 mm di diametro nella porta.

Drill a 22 mm diameter hole into the door.

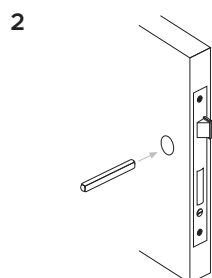

Inserire il ferro quadro nella serratura, rivolgendo la fresata o il foro verso la posizione del foro grano presente sulla maniglia.

Insert the square spindle into the lock. The square spindle's milling or the hole has to be pointed to the handle's grub screw hole.



Apporre una piccola quantità di colla sul diametro esterno della rosetta (sulla parte che andrà inserita nella porta) ed inserirla nel foro sulla porta.

Put a small quantity of glue on the rose's outer diameter (on the part that will be inserted in the door). Insert the rose in the door.

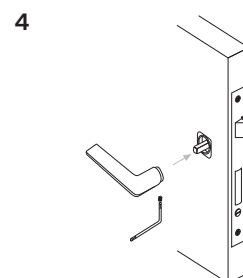

Posizionare la maniglia, e fissarla sul ferro quadro avvitando l'apposito grano finché questo non si blocca.

Position the handle, then fasten the grub screw in the handle's designated hole, until it stops.

## ART. TONDO/ROUND: 231BS - 231BT - 231C - 250F - 258 - 261 - 265 - 266 - 269 - ART. QUADRO/SQUARE: 211BIC

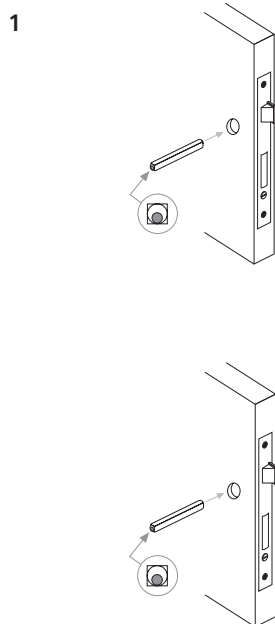

Inserire il ferro quadro nella serratura, rivolgendo la fresata o il foro verso la posizione del foro grano presente sulla maniglia.

Insert the square spindle into the lock. The square spindle's milling or the hole has to be pointed to the handle's grub screw hole.

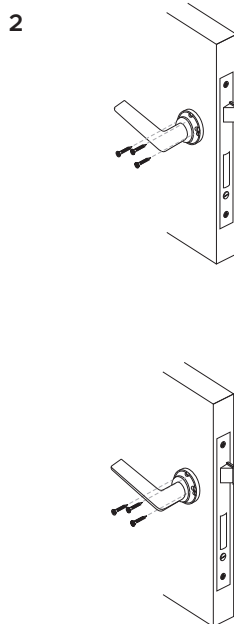

Posizionare la maniglia montata sulla rosetta interna in metallo e fissare con le viti in dotazione.

The handle, mounted on the inner metal rose, must be positioned on the door, and fastened with the screws.

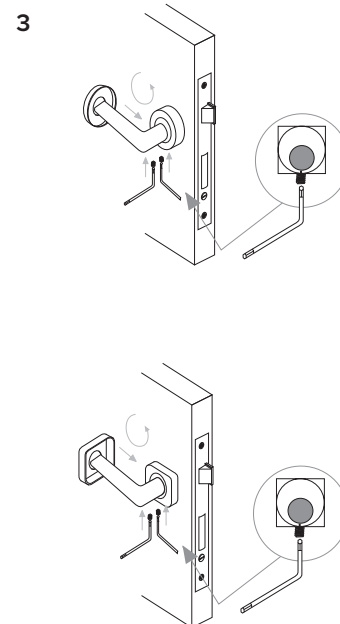

Posizionare l'anello quadrato sulla rosetta interna, facendo particolare attenzione a mantenere la posizione in asse e il foro grano nella parte inferiore.

Fissare l'anello con il grano finché non si blocca. Avvitare il grano nell'apposito foro della maniglia finché non si blocca.

Position the square ring on the inner rose. Position has to be aligned and ring's grub screw hole has to stay in the lower part. Fasten the ring's grub screw until it stops. Fasten the grub screw in the handle's designated hole, until it stops.

## ART. TONDO/ROUND: 208 - ART. QUADRO/SQUARE: 213

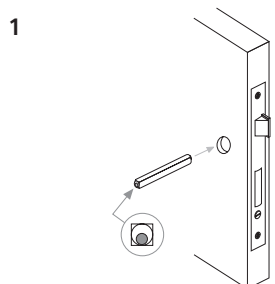

Inserire il ferro quadro nella serratura, rivolgendo la fresata o il foro verso la posizione del foro grano presente sulla maniglia.

Insert the square spindle into the lock. The square spindle's milling or the hole has to be pointed to the handle's grub screw hole.

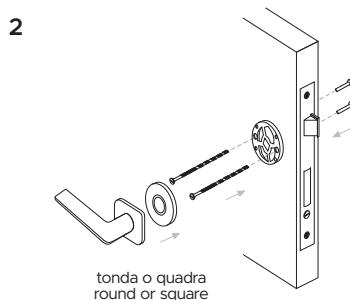

Posizionare la sottorosetta in metallo e fissarla con le viti in dotazione.

Position the metal under-rose aligned with the square spindle, then fasten with the screws.

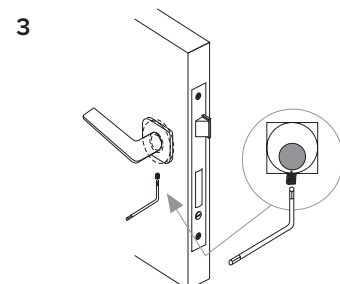

Posizionare la maniglia montata sulla copertina sulla sottorosetta e avvitare il grano nell'apposito foro della maniglia finché non si blocca.

Position the handle mounted on the rose cover on the metal under-rose and fasten the grub screw in the handle's designated hole, until it stops.

# Classe 3

## Class 3

IT La certificazione DIN EN 1906 è una regolamentazione internazionale ed europea per maniglie e pomoli per porte su rosette o placche. La norma DIN EN 1906 stabilisce quattro categorie d'uso in base alla frequenza e alle altre condizioni di utilizzo definite come segue CLASSE 3: alta frequenza di utilizzo, da enti pubblici o persone senza alcuna cura, ad alto rischio di abuso. Per esempio: porte nelle aree pubbliche ed edifici pubblici. Per ottenere questa certificazione, le nostre maniglie sono state sottoposte a vari test che simulano le varie sollecitazioni alle quali sono normalmente esposte nella vita di tutti i giorni. Le nostre maniglie sono state certificate dall'istituto Ift di Rosenheim.

EN The certificates DIN EN 1906 is an International and European standard for door handles and knobs for doors on backplates or roses. The DIN EN 1906 states four categories of use according to the frequency and other conditions of use as follows CLASS 3: high usage frequency, by public or persons with no care, high risk of misuse. For example: doors in public areas and public buildings. To obtain this certificates, our handles have been submitted to various test simulating the different stresses to which they are normally exposed to in everyday's life. Our handles have been certified by the Ift Rosenheim Institute.



# Antifuoco

## Fire rated

IT La maniglia per porte tagliafuoco deve garantire l'apertura della porta durante e dopo un incendio. Pertanto, il funzionamento della maniglia e dei suoi componenti viene garantito con il massimo rigore.

### CARATTERISTICHE:

- Testata per funzionare oltre 200.000 cicli di apertura
- Maniglia in acciaio inox aisi 304
- Certificata secondo la normativa ÖNORM B 3850 presso l'istituto IBS di Postfach (Austria)
- Durata della resistenza al fuoco: 30 minuti

EN A safety handle for fire sets doors has to ensure opening of the door during and after a blaze. Therefore, the functionality is strictly guaranteed both for the handles and for components of the same.

### FEATURES:

- Endurance tested for over 200.000 opening and closing operations
- Handle made of aisi 304 stainless steel
- Certified according to ÖNORM B 3850 relevant rule in IBS Institute based in Postfach (Austria)
- Fire resistance endurance: 30 mins

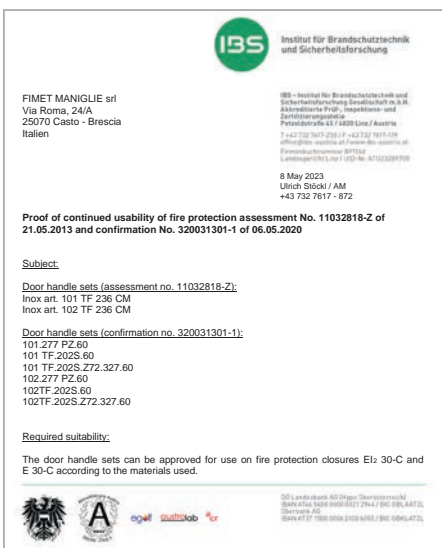

## Condizioni di vendita

Tutte le vendite vengono effettuate alle condizioni generali della ditta venditrice e potranno essere modificate solo con atto scritto della medesima.

Tutte le vendite si intendono fatte “salvo approvazione della ditta”.

I prezzi si intendono franco ns. stabilimento. I prezzi sono sempre da intendersi al netto delle vigenti impostazioni fiscali.

La merce viaggia a rischio e pericolo del committente anche se la spedizione avviene in porto franco

Non verrà accettata merce in restituzione se non previo benestare della ditta venditrice.

La ditta garantisce la ottima qualità dei prodotti e si impegna a sostituire solo il materiale che risultasse difettoso per carenza di costruzione. È però espressamente escluso il risarcimento di ogni eventuale danno.

È nostra cura effettuare le consegne con la massima velocità consentitaci. Non vengono accettate richieste di risarcimento per ritardi di consegna.

Qualsiasi reclamo sarà valido solamente se viene fatto per iscritto entro il termine di 8 gg. dal ricevimento della merce. Il reclamo s'intenderà decaduto qualora il compratore abbia consumato la merce. In caso di reclamo giustificato forniremo, per la merce resaci allo stato originale, della merce corrispondente all'ordine.

Le illustrazioni e i dati tecnici riportati sui nostri cataloghi debbono essere considerati approssimativi potendo i modelli subire delle variazioni e modifiche senza obbligo di preavviso da parte della ditta.

Per ogni controversia che si venisse a creare tra le parti sarà competente l'autorità giudiziaria di Brescia.

## Terms of sale

All sales are made under the Seller's general terms conditions, and modifications may only be made upon written authorisation from the same.

All sales are intended as “subject to the company's approval”.

Prices are quoted ex works and after deduction of the relevant taxes.

All goods travel at the Buyer's risk even if despatched carriage free.

Returned goods will only be accepted upon the Seller's approval.

The manufacturer guarantees the quality of the products and undertakes to replace only goods found to have workmanship defects. Damages will not be refunded.

We will do our utmost to make deliveries as promptly as possible. Claims for delayed deliveries will not be accepted.

Claims will only be valid if made in writing within 8 days of receipt of the goods. Claims will not be valid if the buyer has used the goods. In the case of justified claims and goods returned in their original state, we will supply goods corresponding to the order.

The drawings and technical data shown in our catalogues are to be considered as approximate since the models are subject to variation or modification at any time without prior notice.

Any disputes between the parties will be put before the Court of Brescia.

<sup>IT</sup> I prodotti e il catalogo sono soggetti ad aggiornamenti. Le colorazioni e le raffigurazioni hanno valore indicativo e possono presentare leggere differenze dal prodotto originale in quanto riportate attraverso un procedimento di stampa. Eventuali differenze tra il prodotto finito e la sua presentazione non possono dar luogo ad alcun reclamo.

<sup>EN</sup> Catalogue and products are subject to improvements. Colors and pictures in the catalogue are not binding and may slightly differ if compared with the product since they are obtained by a printing process. Possible differences between ready-made product and its presentation cannot cause any complaint.

**Fimet maniglie srl**

Via Roma 24/A  
25070 Casto (Bs) - Italy  
Tel. +39 0365 870383  
Fax +39 0365 879530  
info@fimet-handles.com

**Catalogo 2025**